

# What's my job in court



An answer and activity book for kids who are going to court.

# What's my job in court?



An answer and activity book for kids who are going to court

Design and illustration by Laurie Wonfor-Nolan

## What's in this book?

	PAGE
Introduction .....	2

The courthouse ....	3
---------------------	---

### People in court:

Judge .....	6
Crown attorney .....	7
Defense lawyer .....	8
Accused .....	9
Witness .....	12, 13
Court reporter .....	14
Clerk of the court .....	19
Court security officer .....	21
The jury .....	27

People in court punch-out and courtroom .....	16, 17
---	--------

### Activities:

	PAGE
Maze .....	4
Connect the dots .....	10
Colour fun .....	5, 11, 20
What's wrong in this courtroom? .....	23
Match game .....	24
Find the word .....	25
Courtroom crossword .....	29

Court rules .....	22
Guilty and not guilty .....	26
What happens when it's over .....	28
Answer page .....	31
Information for the Crown .....	32

What does that mean? ...	30
--------------------------	----

(Glossary)



Hi, I'm Yasmin. My friends  
- Alex and Teresa and I have  
an important job to do.  
Just like you.



What  
job?

We have to go to court and  
tell the judge about  
something. Maybe it's  
something we saw or  
heard. Maybe it's something  
that happened to us.  
Whatever it is, telling the  
judge about it makes us  
witnesses.



By reading this book and  
- doing the activities, we'll learn  
about being witnesses.  
Together we'll think of questions  
to ask that can make our  
job easier. We'll also find out  
about court and the people  
who work there.

# What is a courthouse?

In most towns and cities, there is a building called a courthouse.

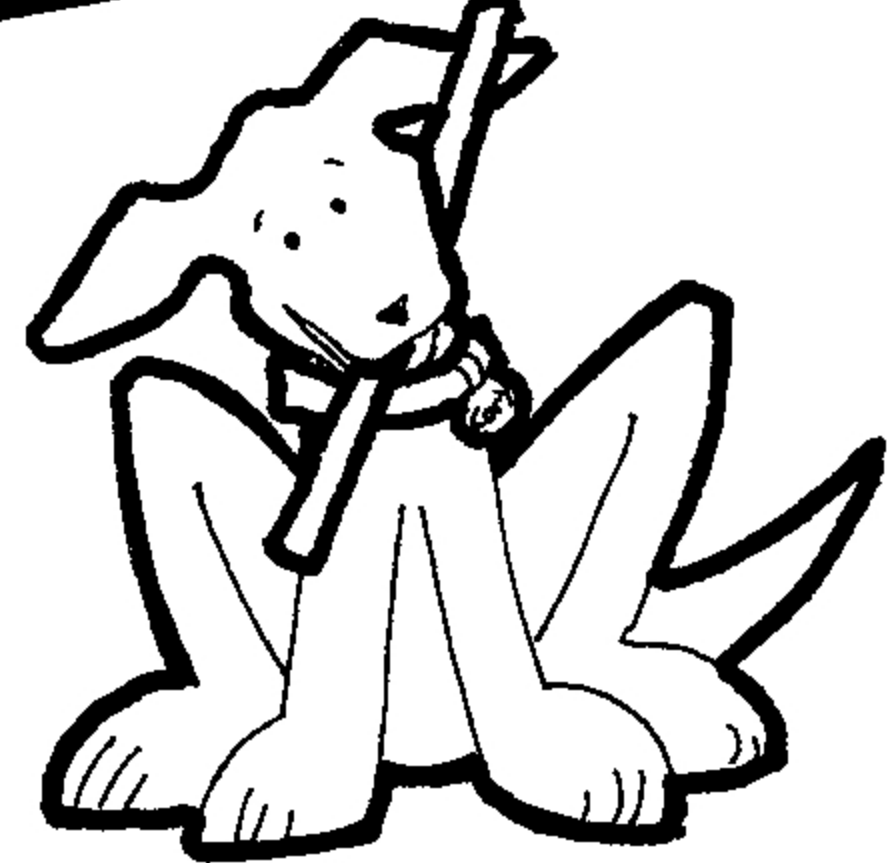

It's a place where judges, and sometimes juries, decide if someone has broken the law.

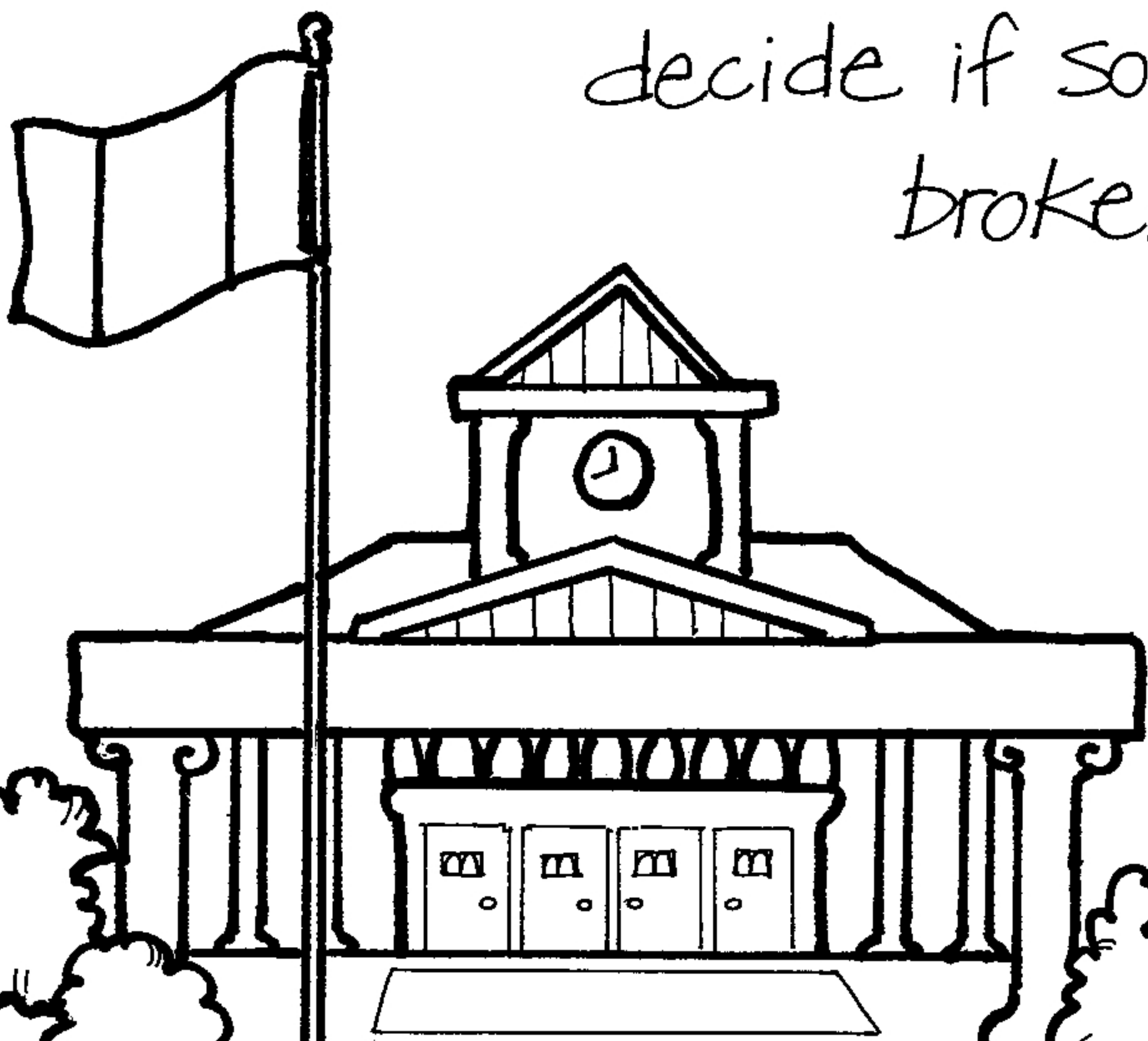

Can you complete the courthouse by filling in the Canadian flag and by printing the name of your city or town above the front doors?



# Things to do

A lot happens before people get to court. Let's trace some of the steps.

it's amazing.

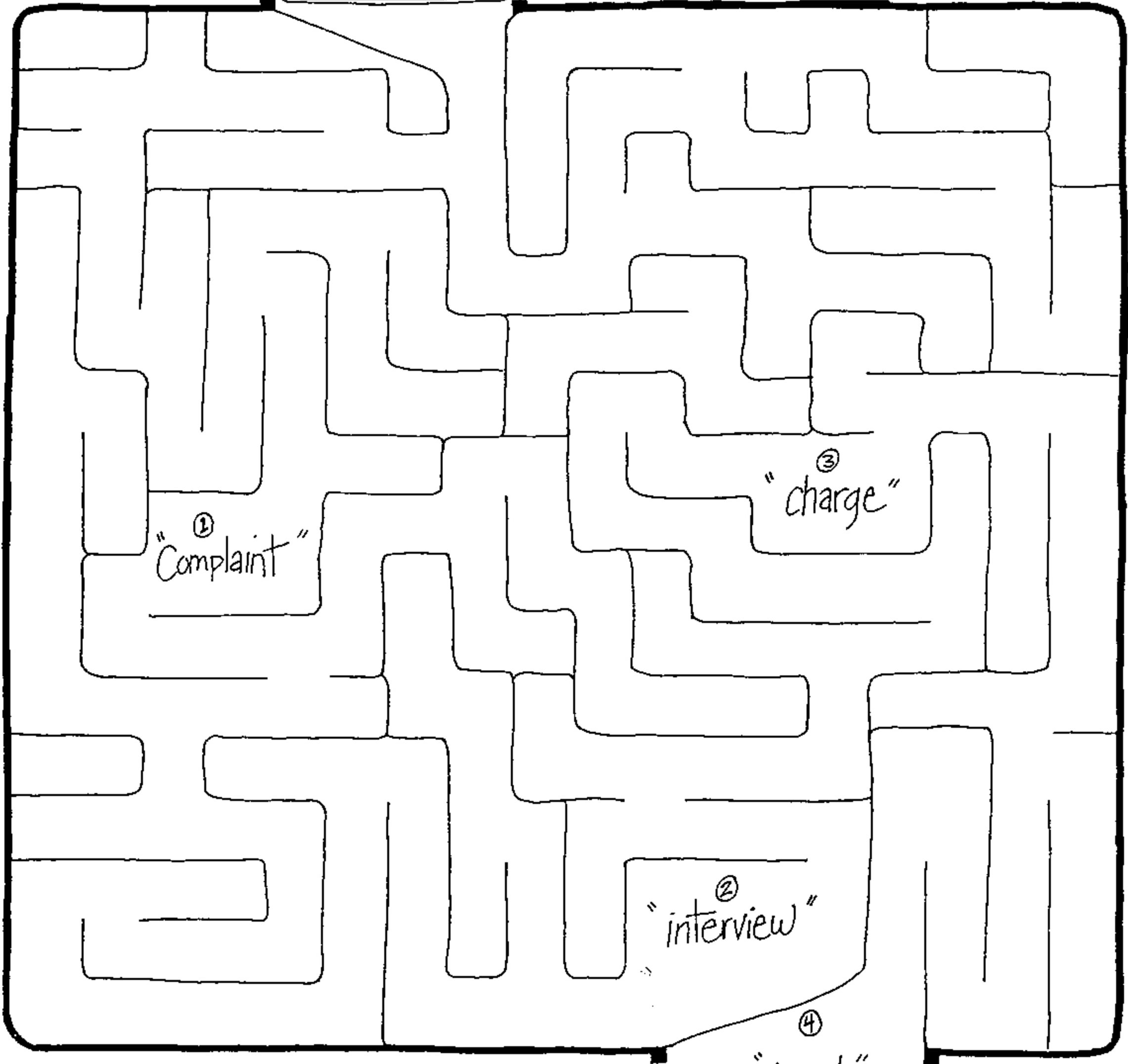

# before Court



Dress to be neat and comfortable.

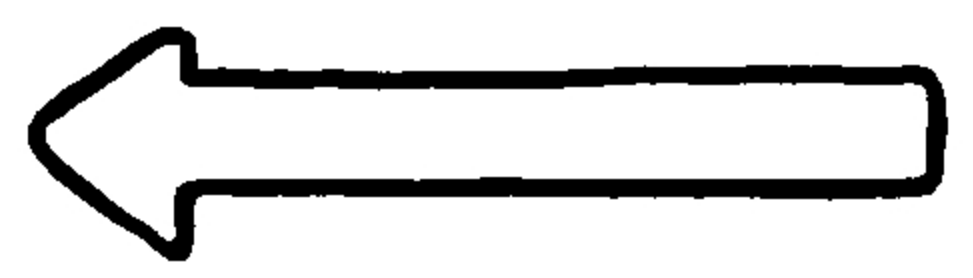

Eat a snack.

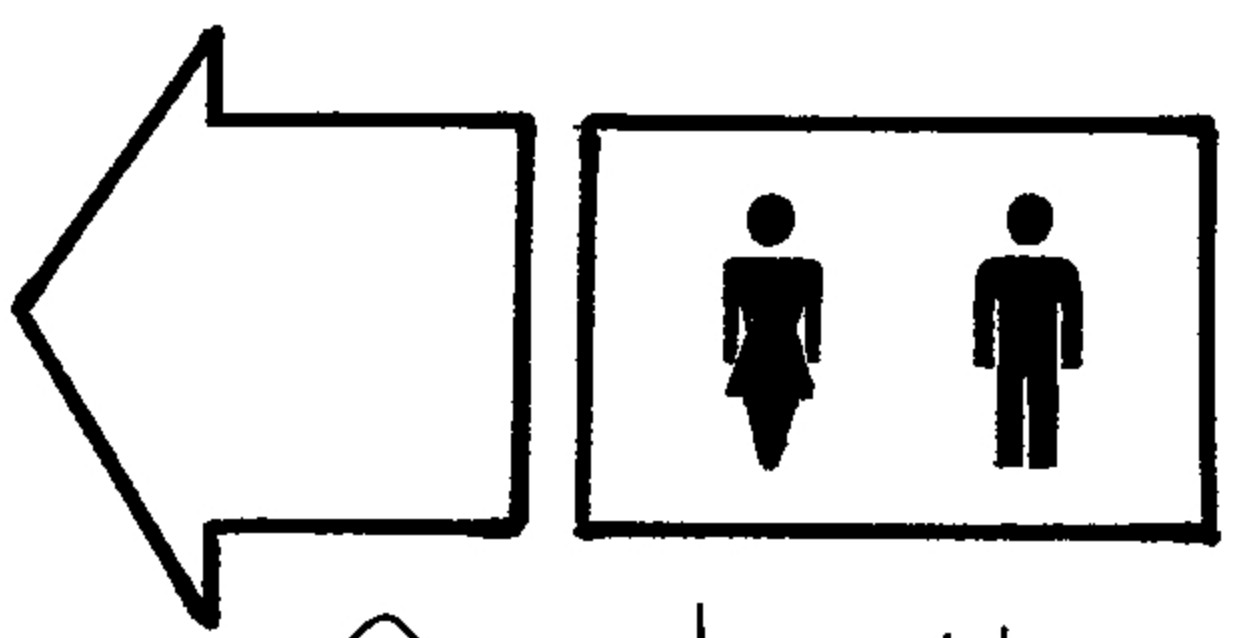
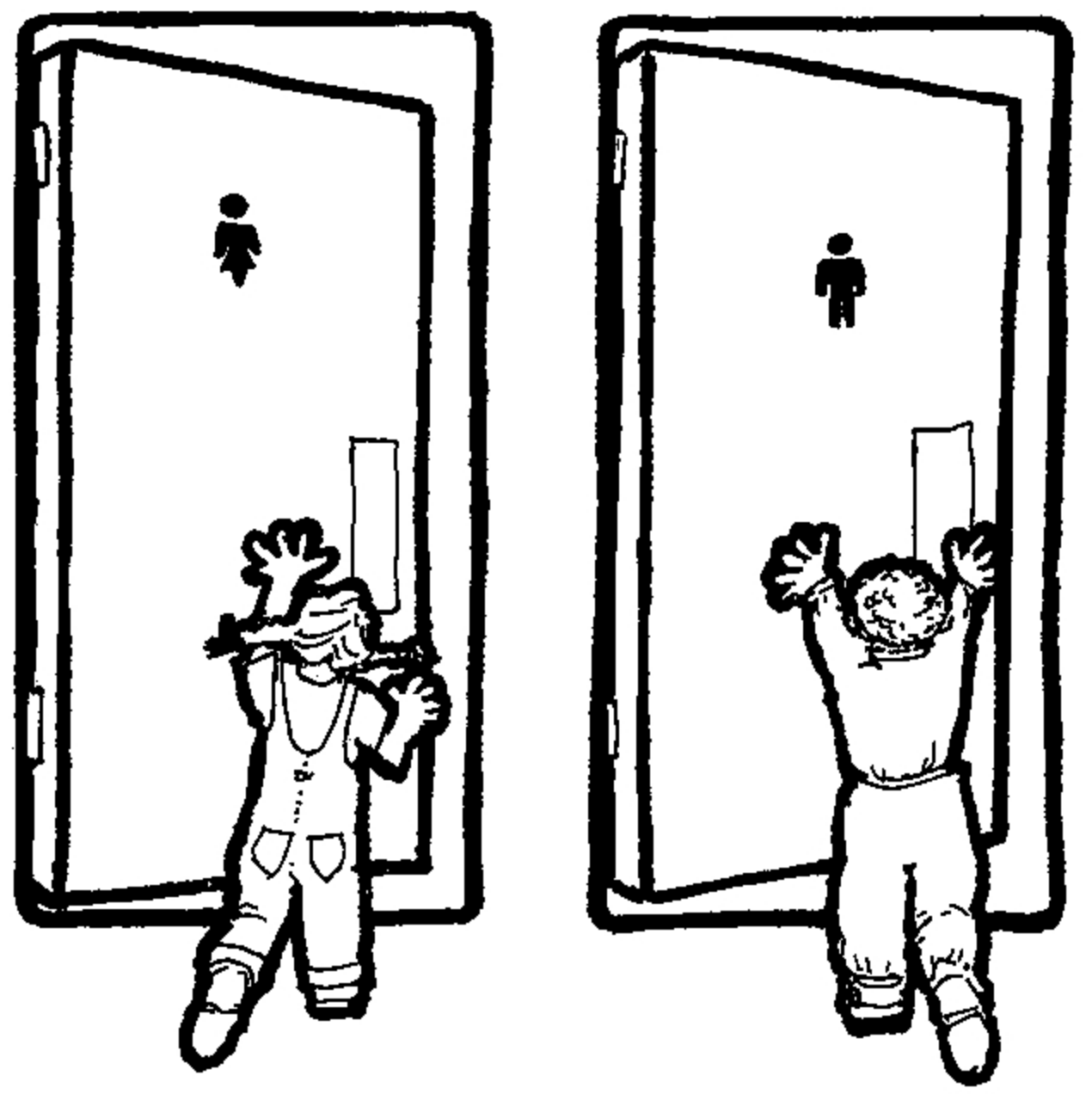
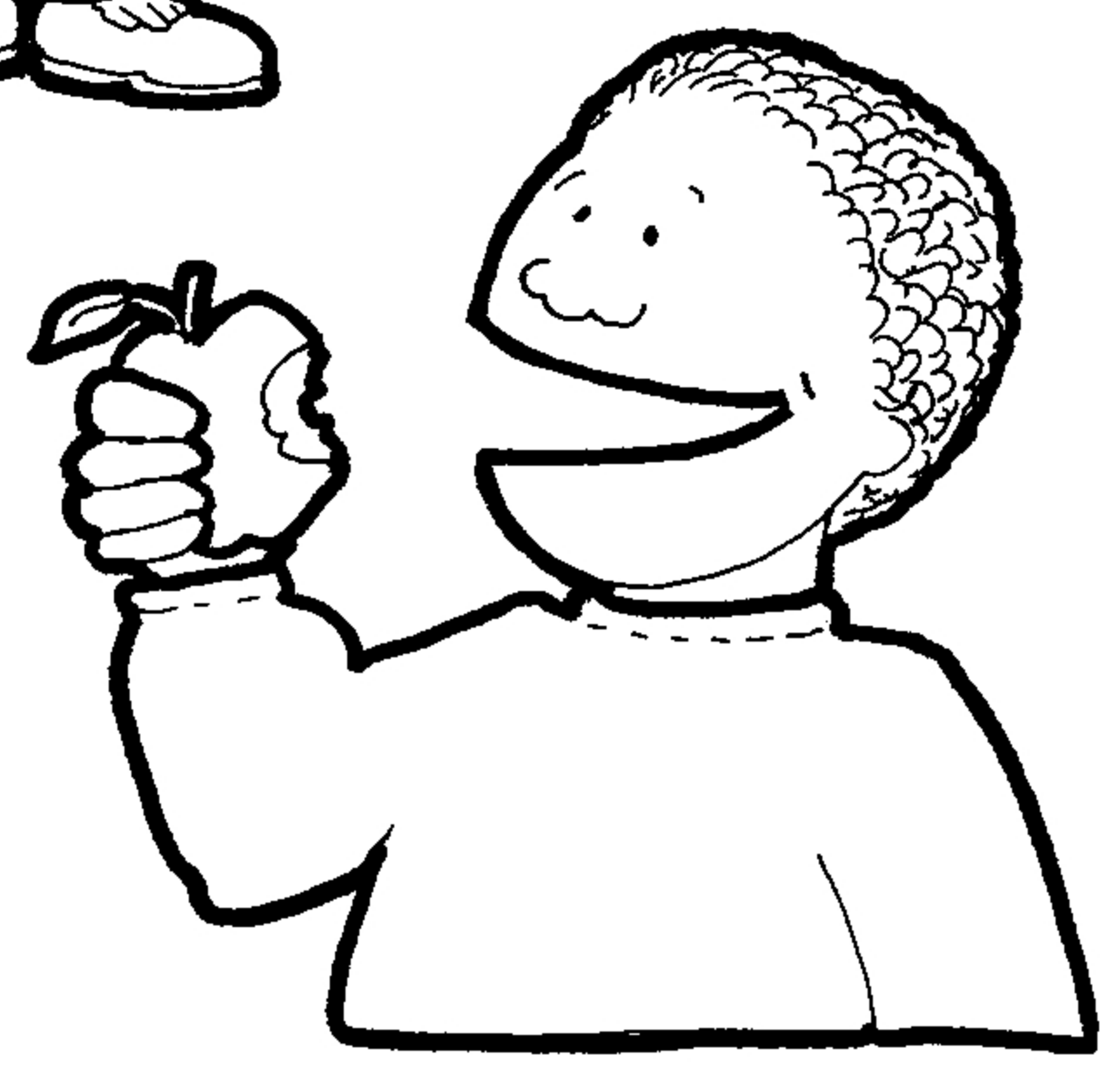

Go to the washroom.

(If you need some help with the maze turn to page 31.)

# What is the judge's job?

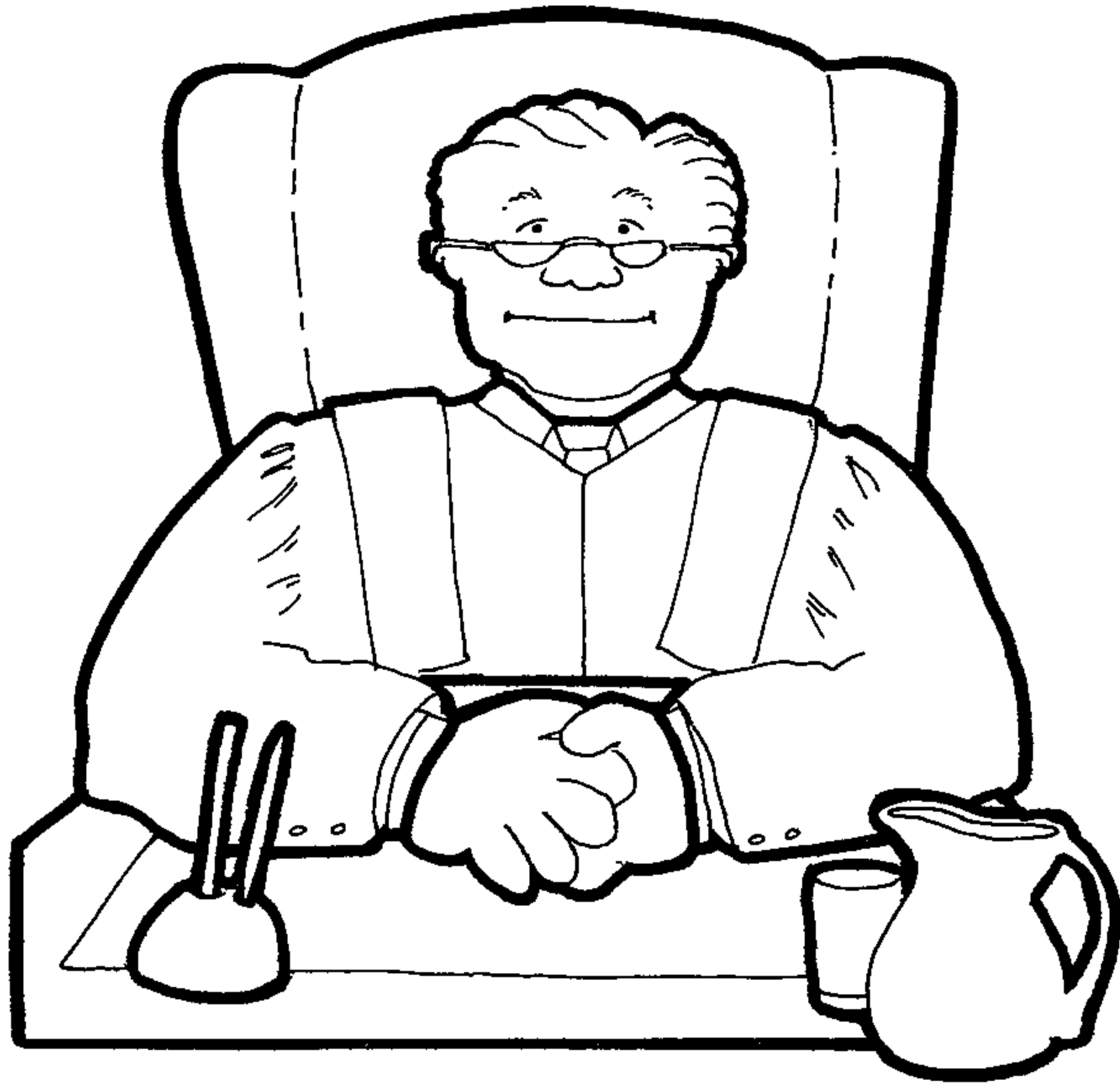

It's the judge's job to listen to everything that everyone says in court.

We can call the judge "Your Honour" when it's our turn to talk.

It's also the judge's job to know the law and to decide whether the law has been broken or not.

Who acts like a judge at school?

---



At the beginning, the judge may ask us some questions like these:

Q. How old are you? \_\_\_\_\_

Q. What grade are you in? \_\_\_\_\_

Q. Do you know what an oath is? \_\_\_\_\_

Q. What does it mean when you "swear to tell the truth"? \_\_\_\_\_

Q. What do you think might happen if people do not tell the truth in court? \_\_\_\_\_

---

If we need some help in finding answers to some of these questions before we go to court, we can ask the Crown.

# What does the Crown do?

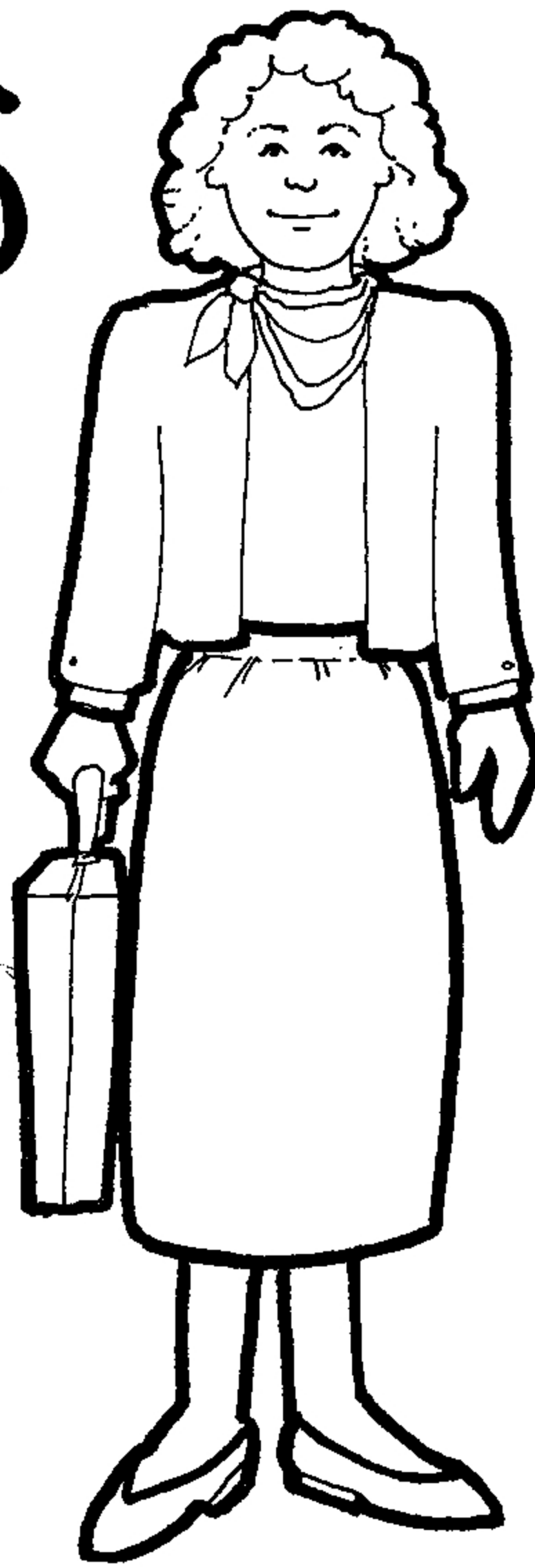
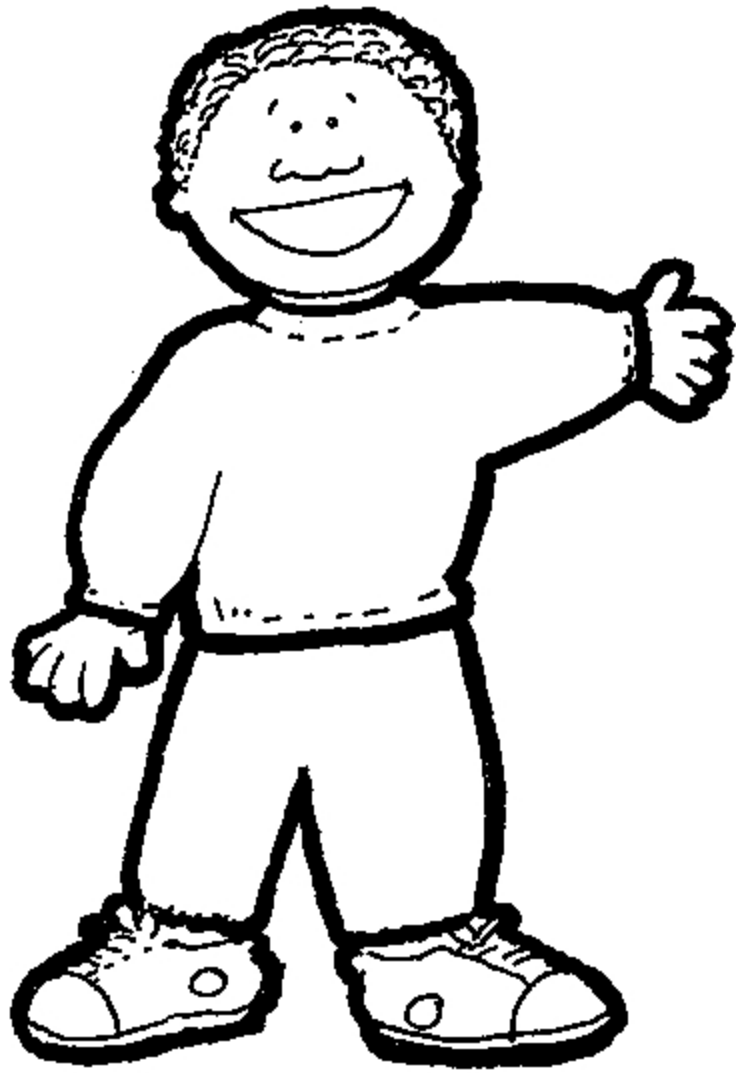

The Crown attorney or Crown prosecutor helps us to do our job as witnesses.

The Crown does this by asking us questions so that the judge can listen to our answers.

Sometimes the Crown wears a robe for court.

Can you answer these questions and show your answers to the Crown?

Q. Do you think it will be hard to talk to the Crown about what happened? Why? \_\_\_\_\_

\_\_\_\_\_

\_\_\_\_\_

Q. What questions do you want to ask the Crown?

\_\_\_\_\_

\_\_\_\_\_

\_\_\_\_\_

Q. Do you know someone you would like to come to court with you? Who? \_\_\_\_\_

Q. Is there anything about going to court that scares you? What? \_\_\_\_\_

\_\_\_\_\_

\_\_\_\_\_

To see how the Crown looks in her robe, just trace it, cut it out, and try it on her. ↴

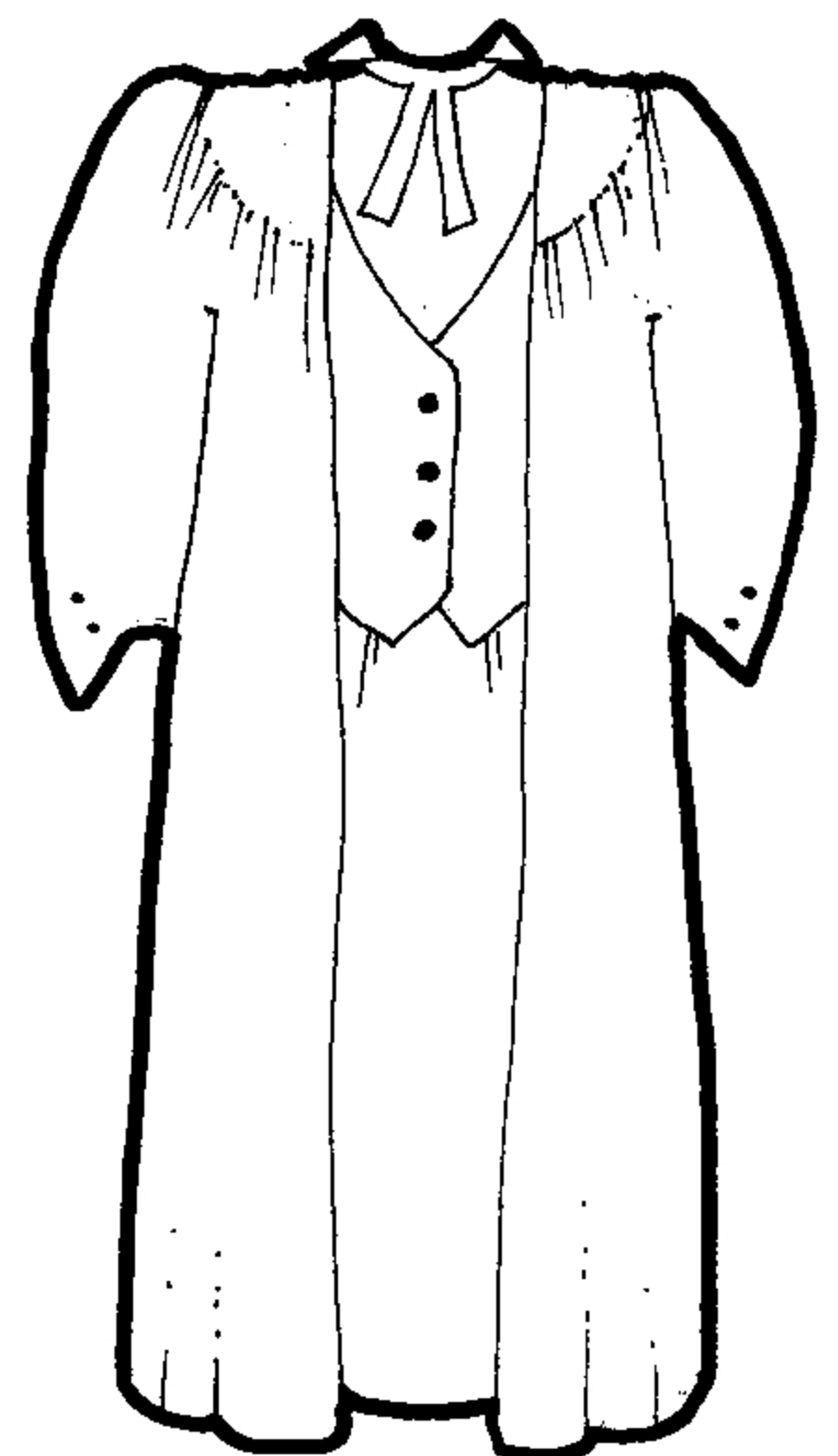



# What is the defense lawyer's job?



The defense lawyer's job is to help the accused. The accused is the person charged with breaking the law.

Can you give an example of breaking the law?

---

---

To do a good job, the defense lawyer tries to find out if we've made a mistake, or if we can't remember something, or if we've made something up. That's why the defense lawyer gets a chance to ask us questions after the Crown has finished asking us questions.

We've got to listen to everyone's questions carefully and understand them before we answer.

Sometimes when we're talking in court, the defense lawyer may stand up and interrupt us to talk to the judge. Don't worry. We haven't done or said anything wrong. No one is angry at us. All we have to do is stop talking until the judge or the Crown asks us to go on.

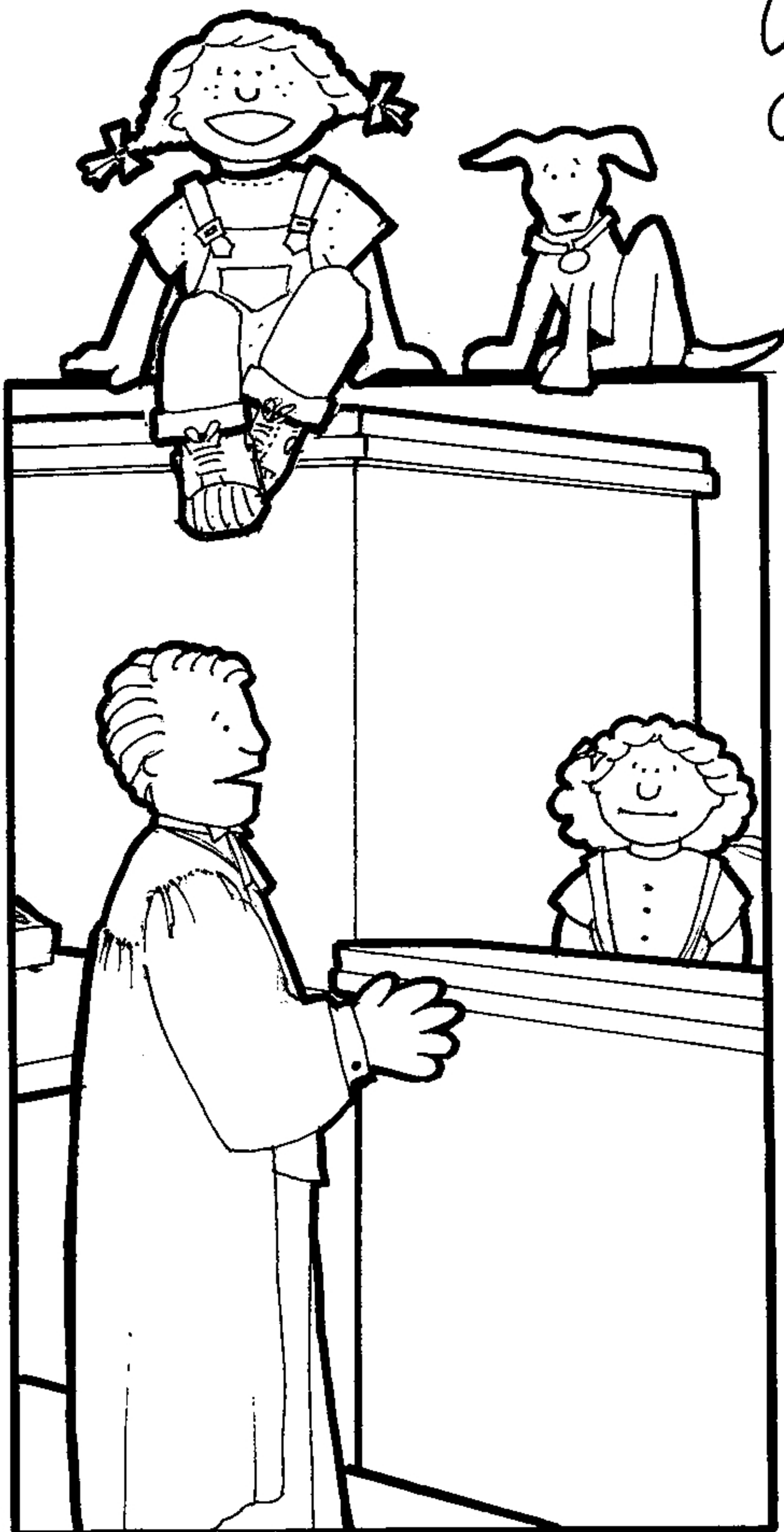

# Who's the Accused?



The person whom the police have charged with breaking the law is called the accused.

Maybe we know the accused; maybe we don't. Maybe we've seen the accused before, maybe we haven't.

Sometimes when we do our job as witnesses, we end up talking about the accused. The judge or the Crown may ask us if we see the person that we are talking about in court.

If we do, we should point to the person and tell the judge what the person is wearing.

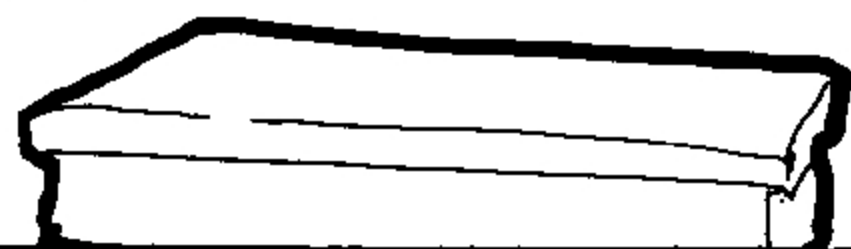

# Connect the dots

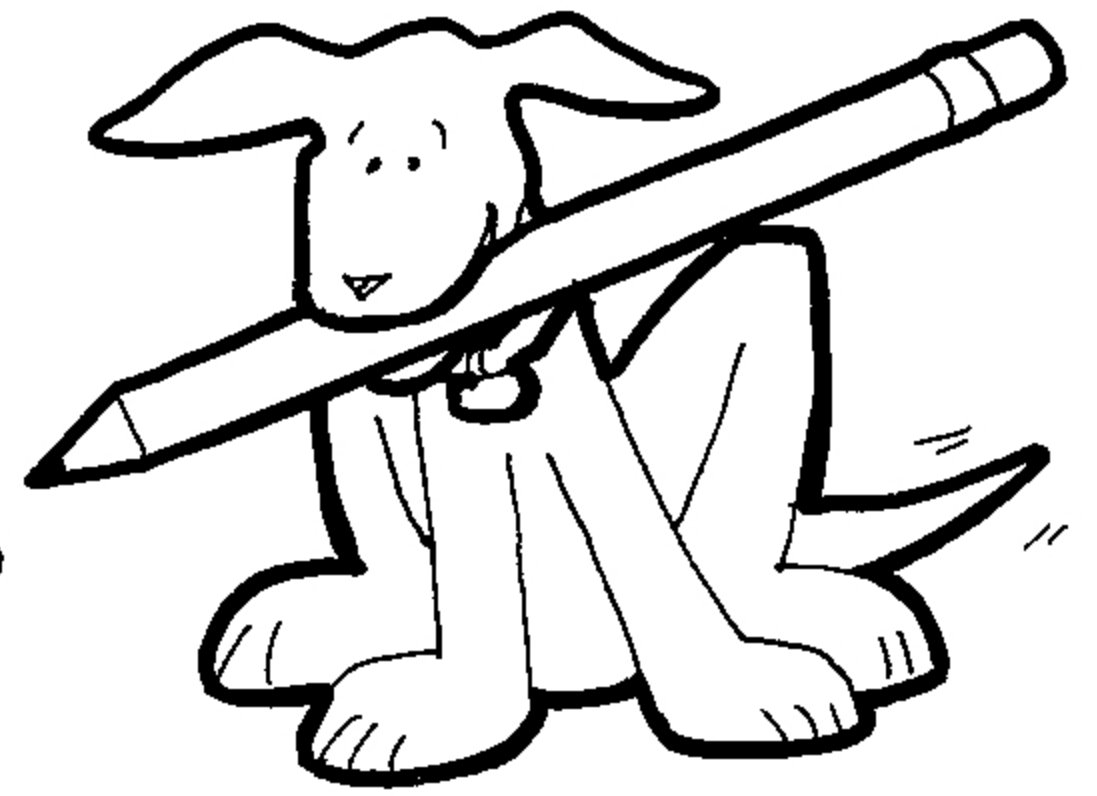
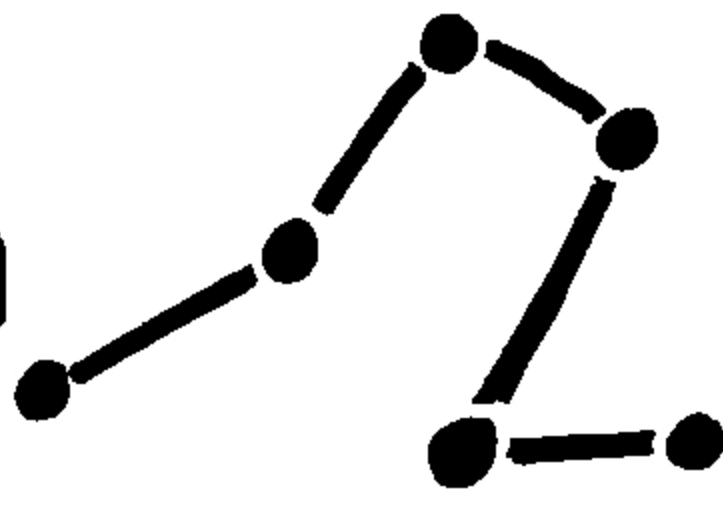

and circle the things that belong in the courtroom.  
 If you don't know what to circle, look at the courtroom in the middle of the book.  
 (Dot to dot answers are on page 31.)

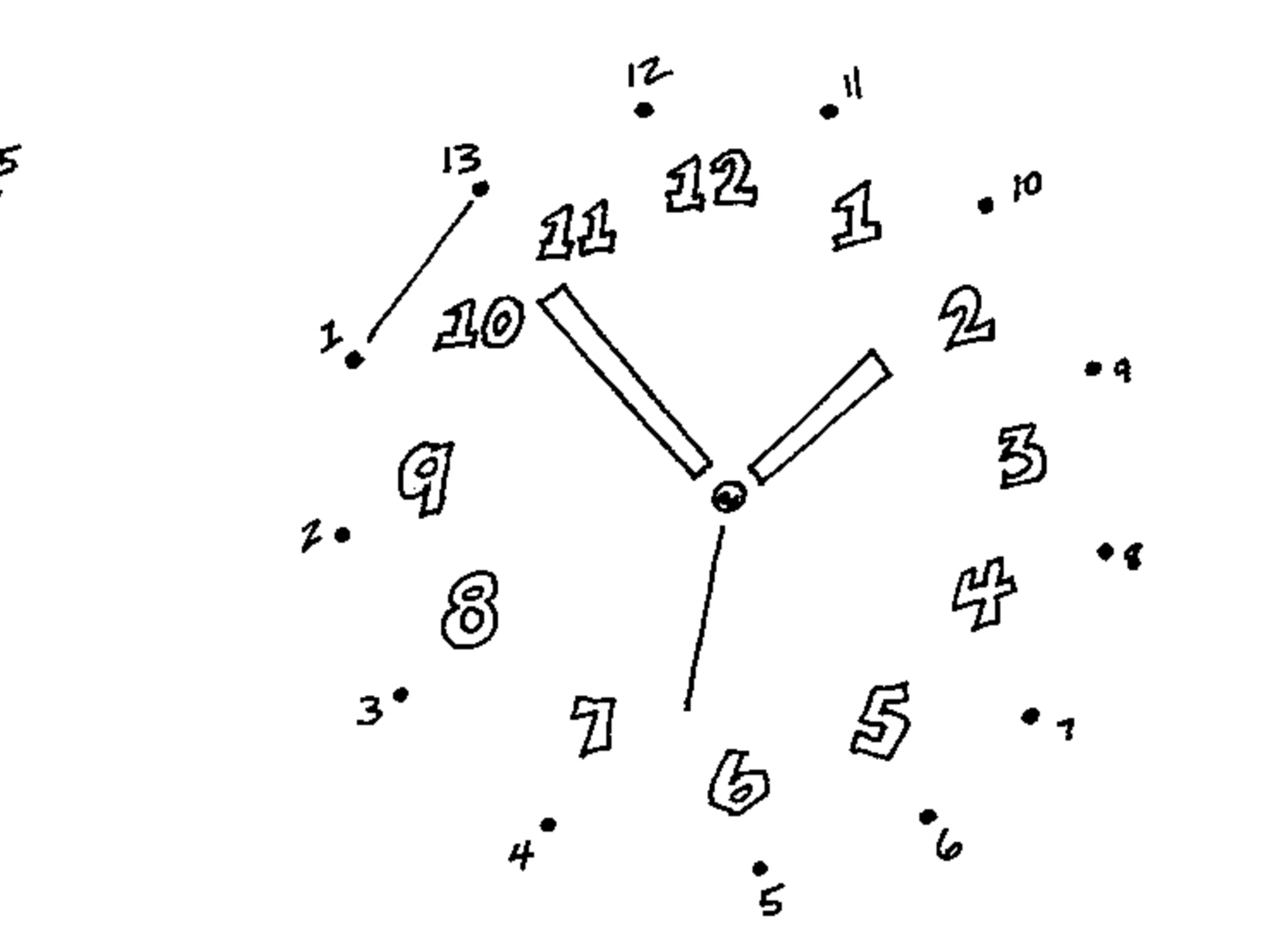
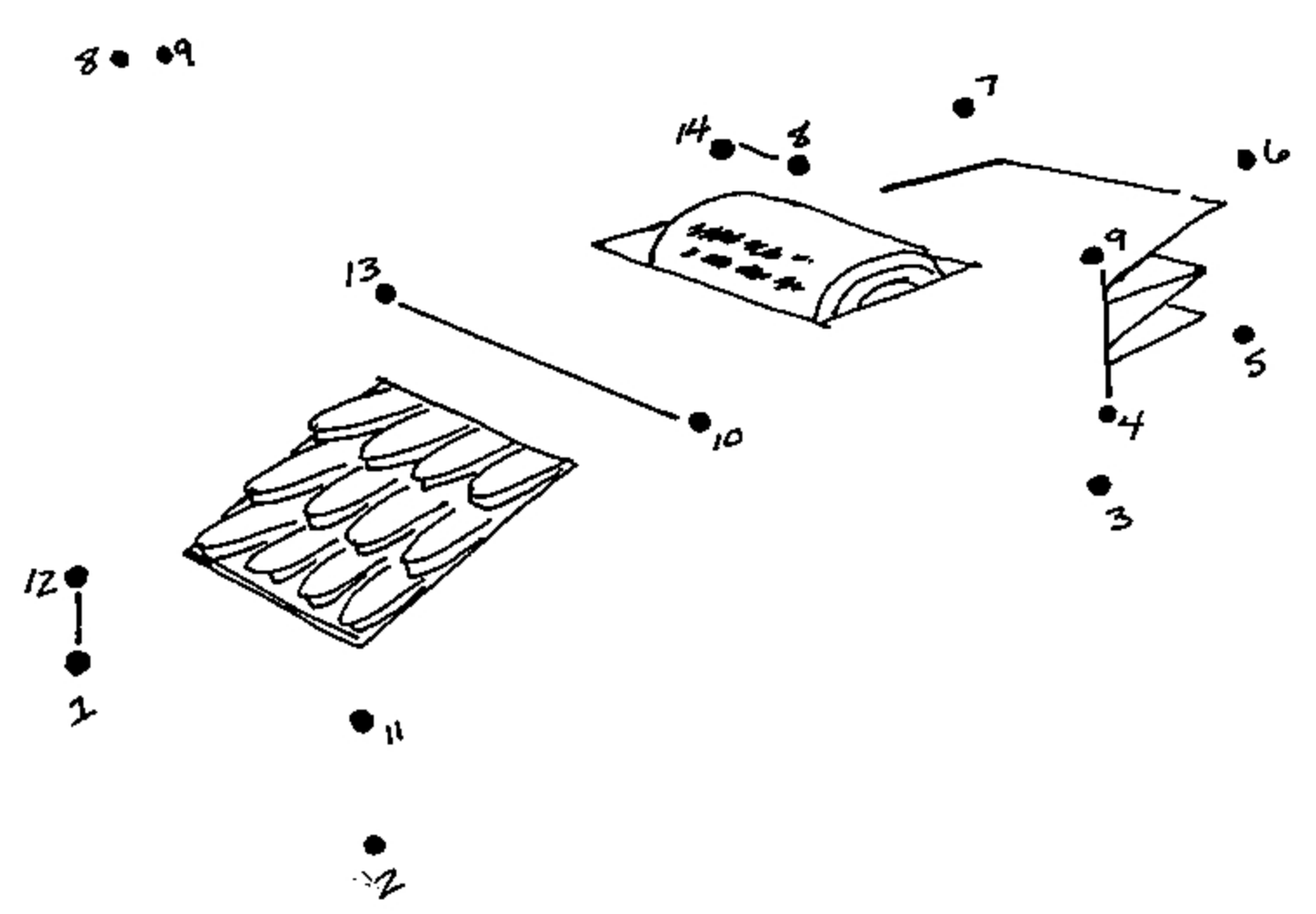
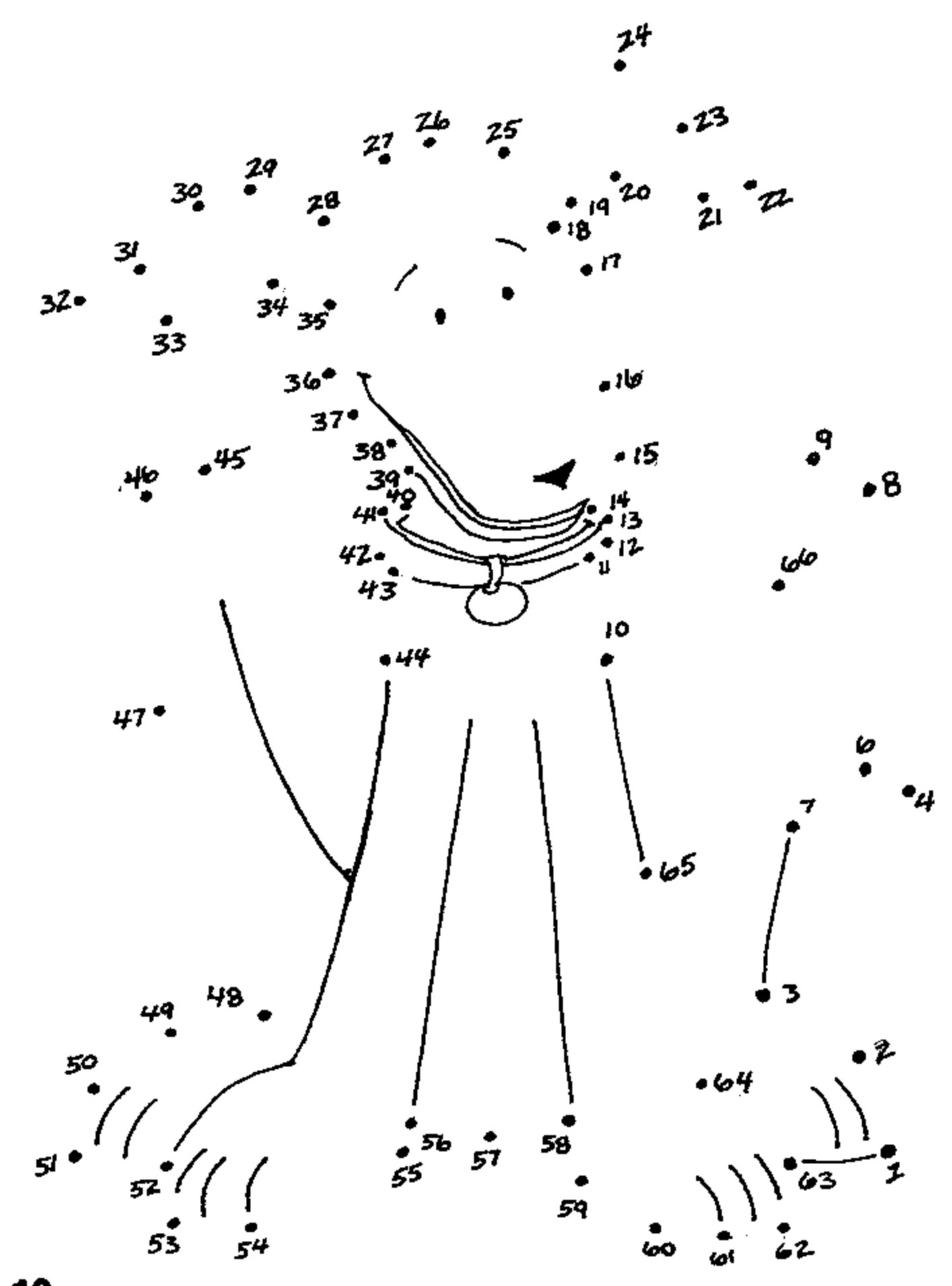
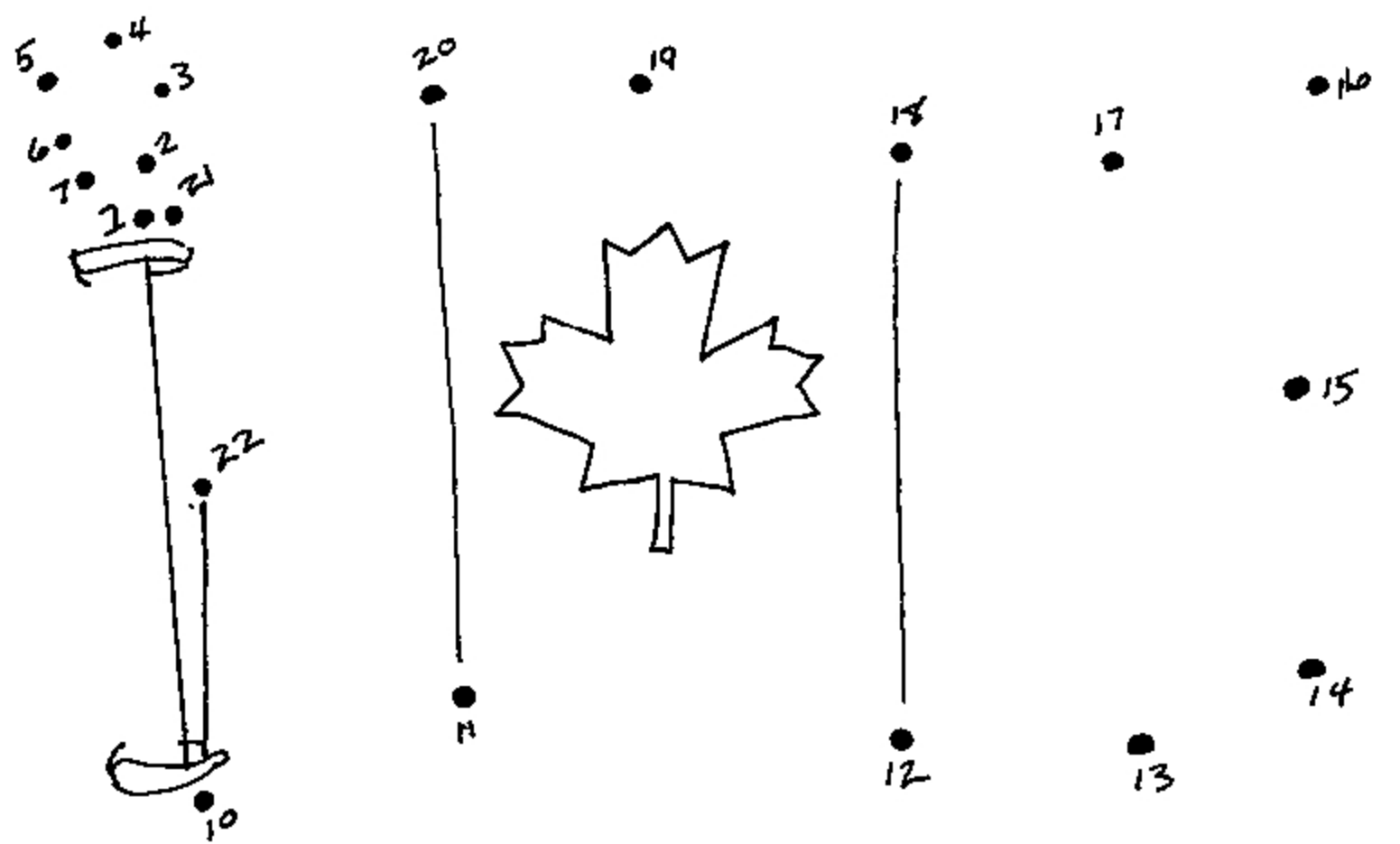

Alex is learning all about  
court and being a witness.

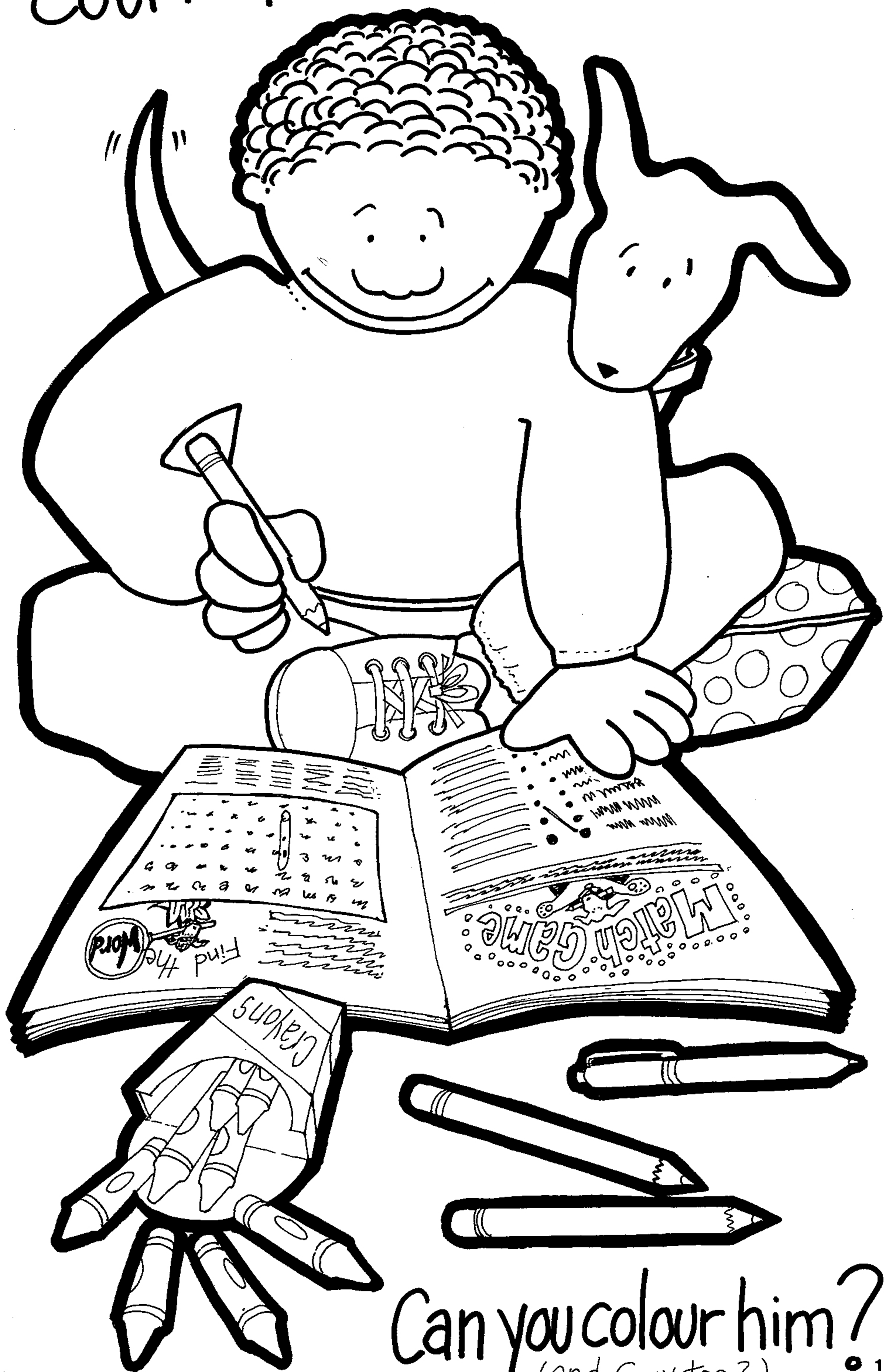

Can you colour him?  
(and Cory too?)

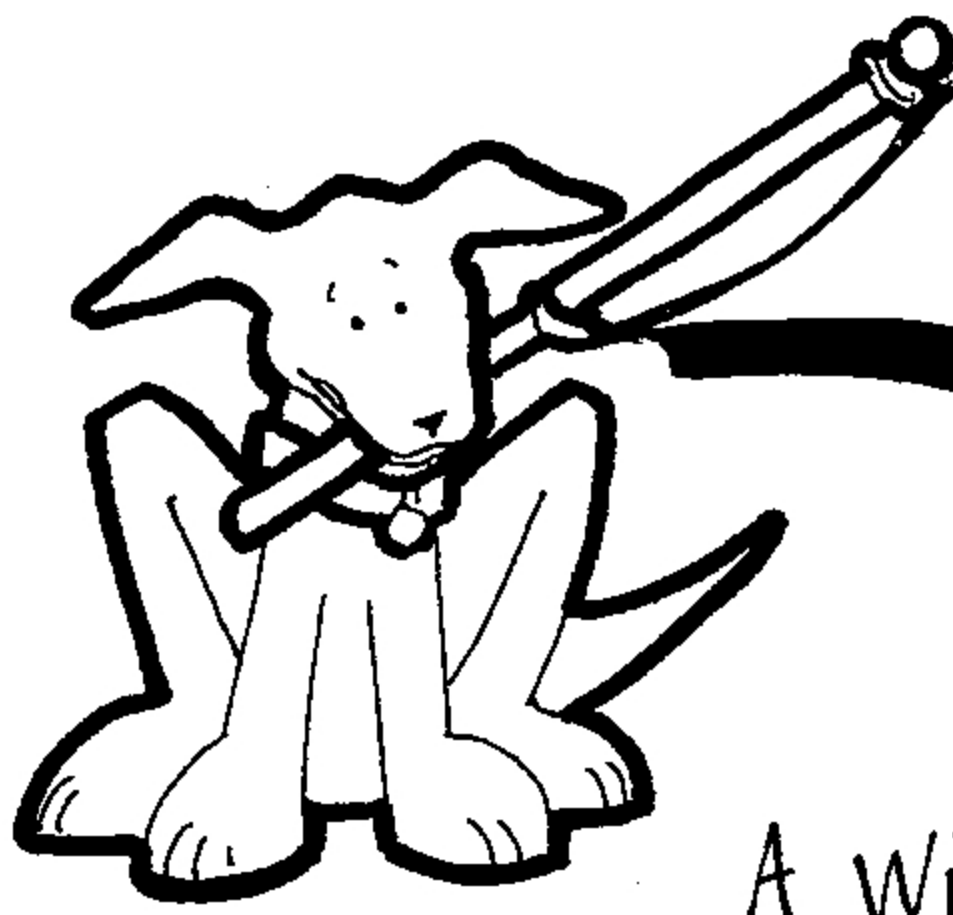

# What does

A witness is a very important person in court. Our job as witnesses is to listen to questions and to give answers for the judge to hear. This is called giving evidence.

The most important thing about being a witness is **TELLING THE TRUTH**.



# What if

1. You're asked a question and you don't understand it?

---

2. You're asked a question and you can't remember the answer?

---

3. You're asked an embarrassing question?

---

4. You cry in court?

---

5. You need to go to the washroom?

---

6. You're asked more than one question at a time?

---

(If you need some help with these questions, turn to page 31.)

# a witness do ?

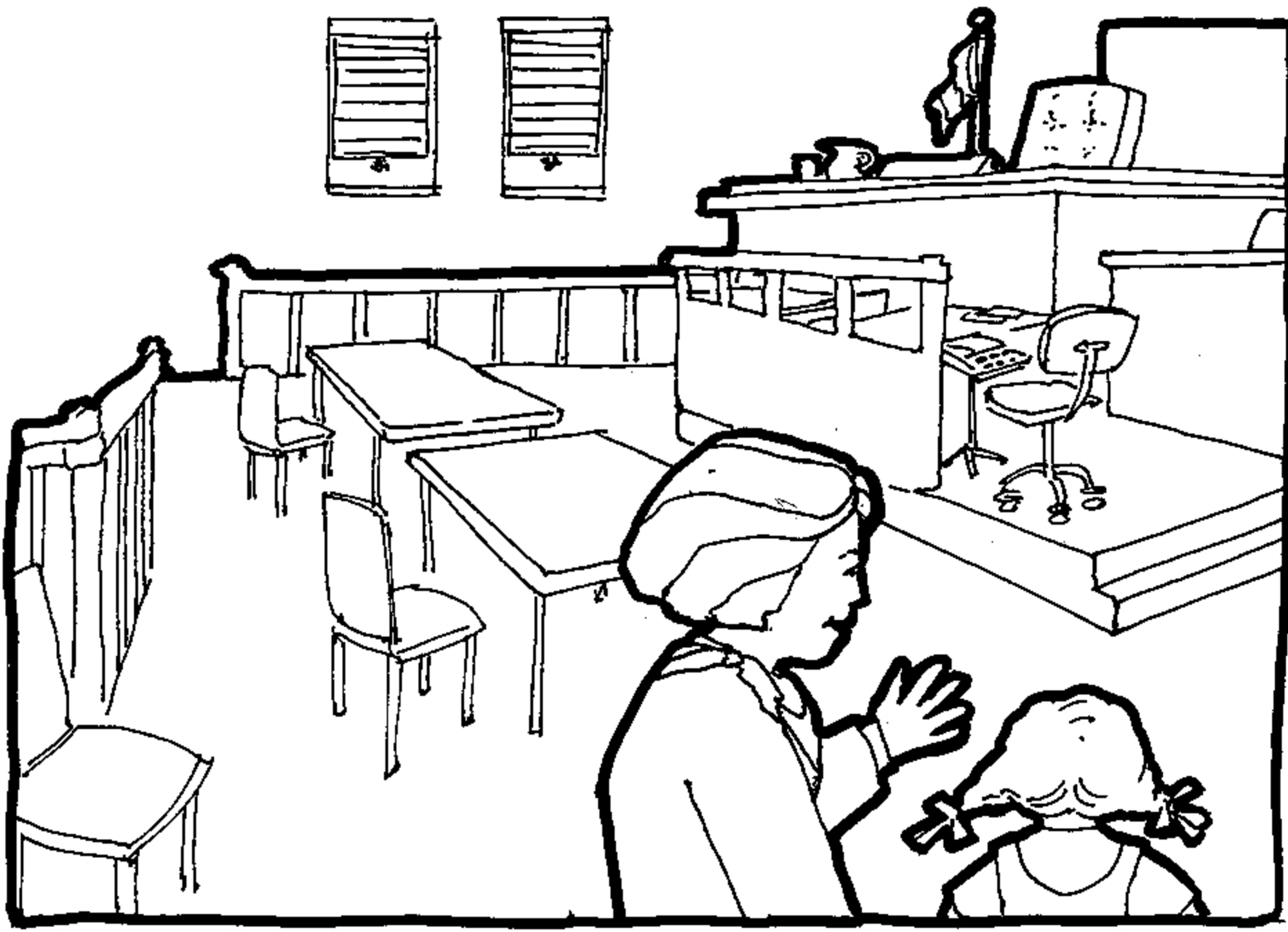

The Crown or someone who works with the Crown should **show us the courtroom** before it's time for us to be witnesses. If we have any questions after we see the courtroom, we can always ask the Crown.

Sometimes when kids talk to the police and the social worker, a **videotape** is made. Do you know if a videotape was made of you? If there was, the Crown might show it to you. Kids sometimes end up watching it in court with the judge.

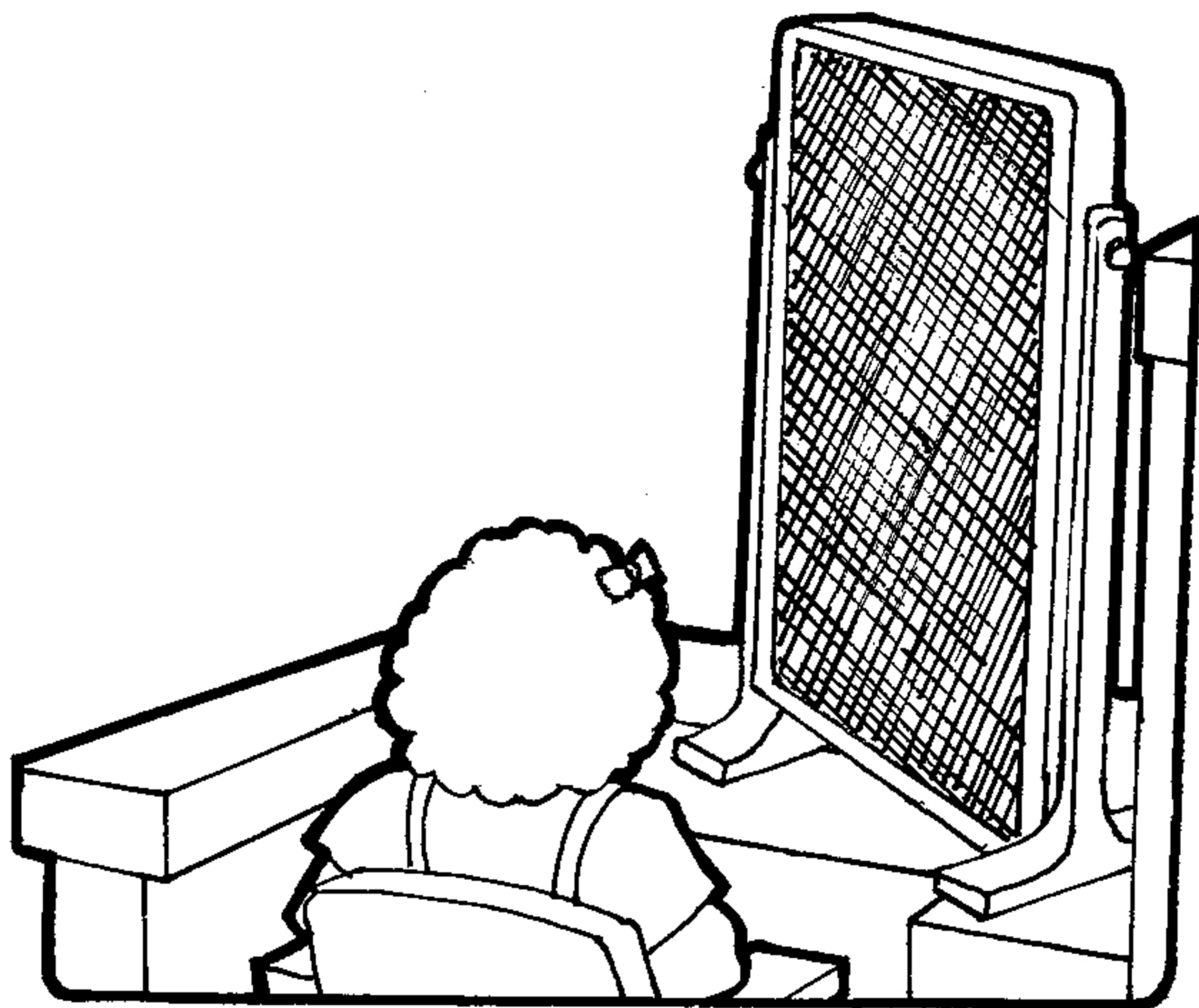
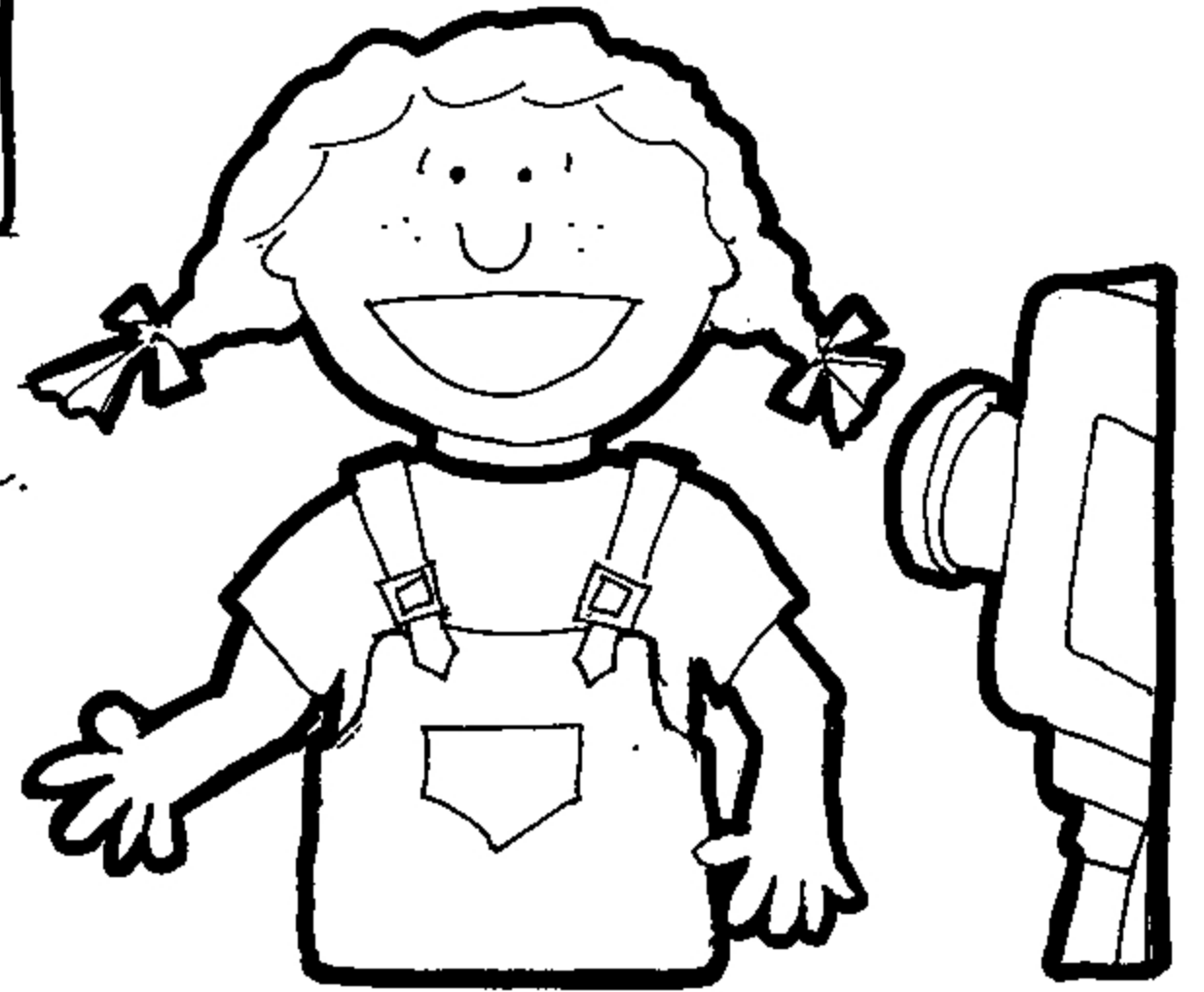

Some kids are scared about going to court. If we're scared, we should tell the Crown why. Sometimes the Crown can talk to the judge about letting us sit behind **a screen** while we do our job as witnesses. The judge decides if a screen should be used. Anyone who wants to see what a screen looks like can ask the Crown if there's one in the courthouse.

Some courthouses have a special **courtroom TV**. If the judge decides that it's best for us to stay outside the courtroom, we can do our job as witnesses in another room. The judge stays in the courtroom and listens to us tell about what happened on TV.

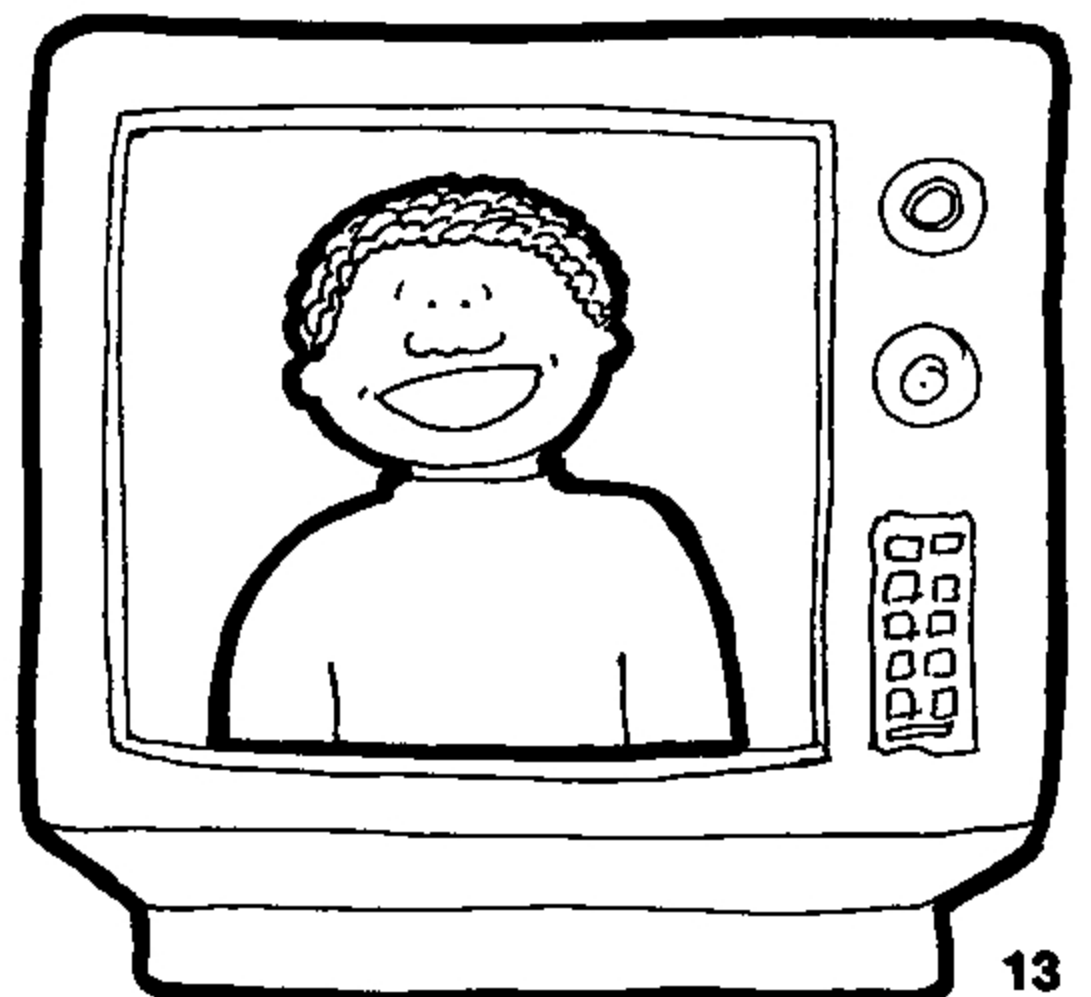

# The Court Reporter

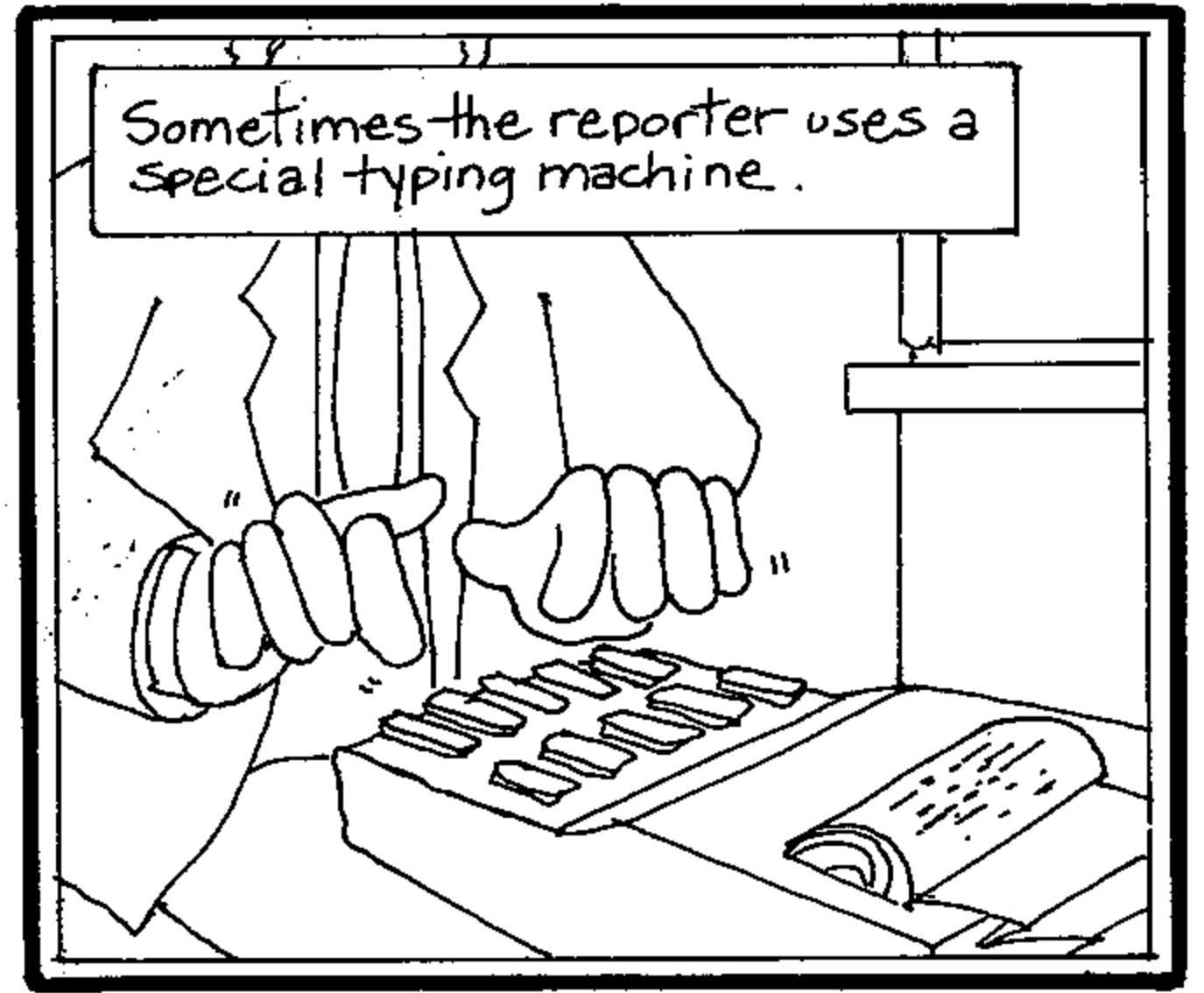
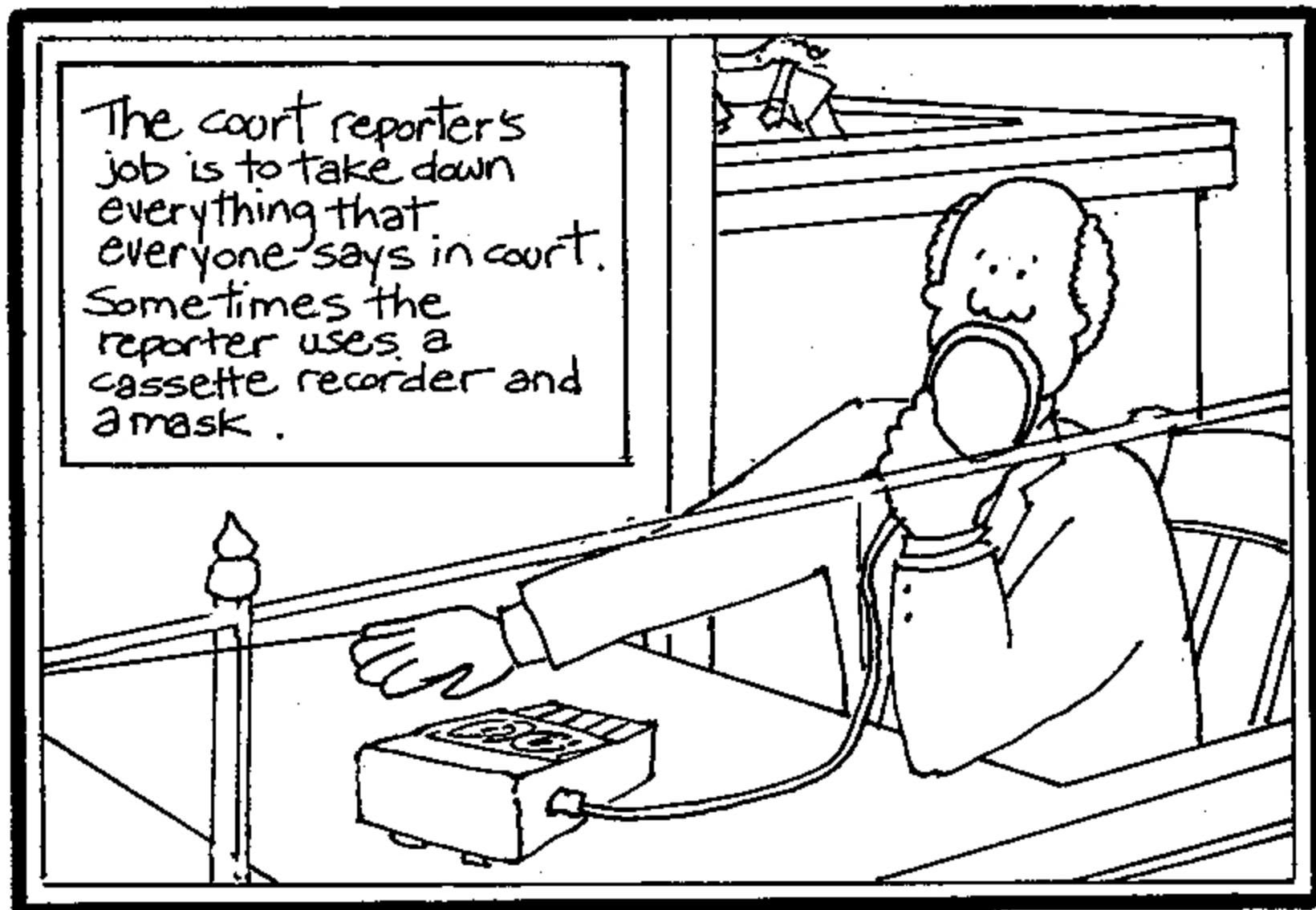

It's better if only one person speaks at a time.

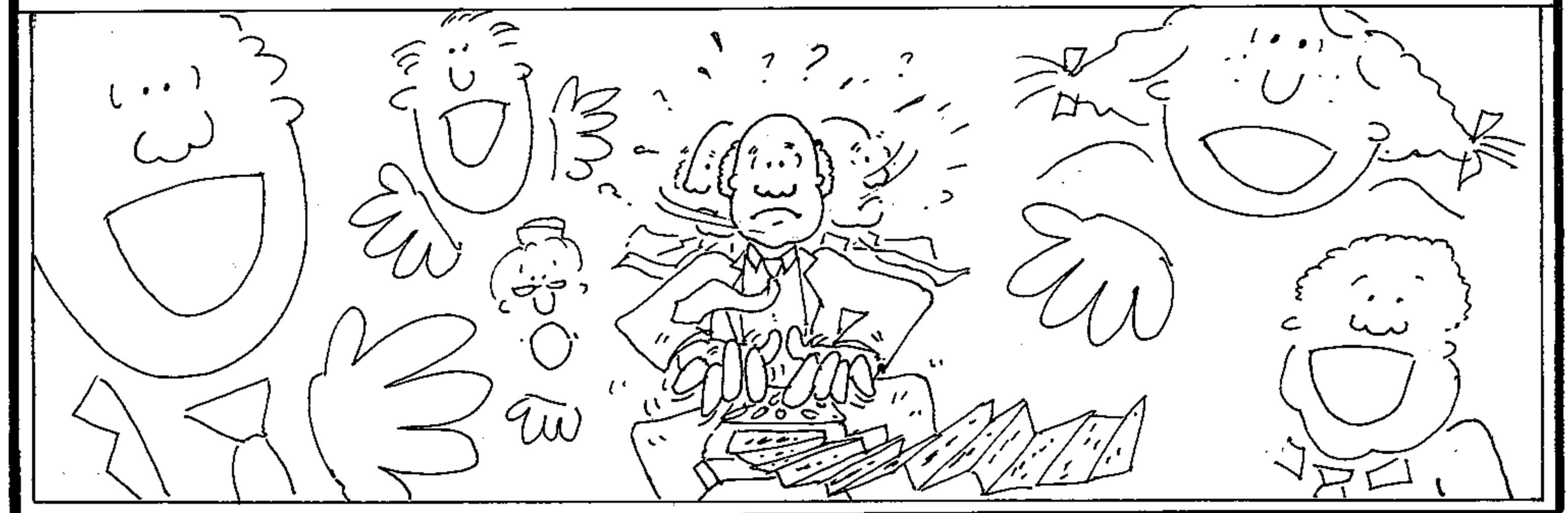

# Where does everybody sit?

Court is starting on the next page. Can you put everybody in their places? Here's how!

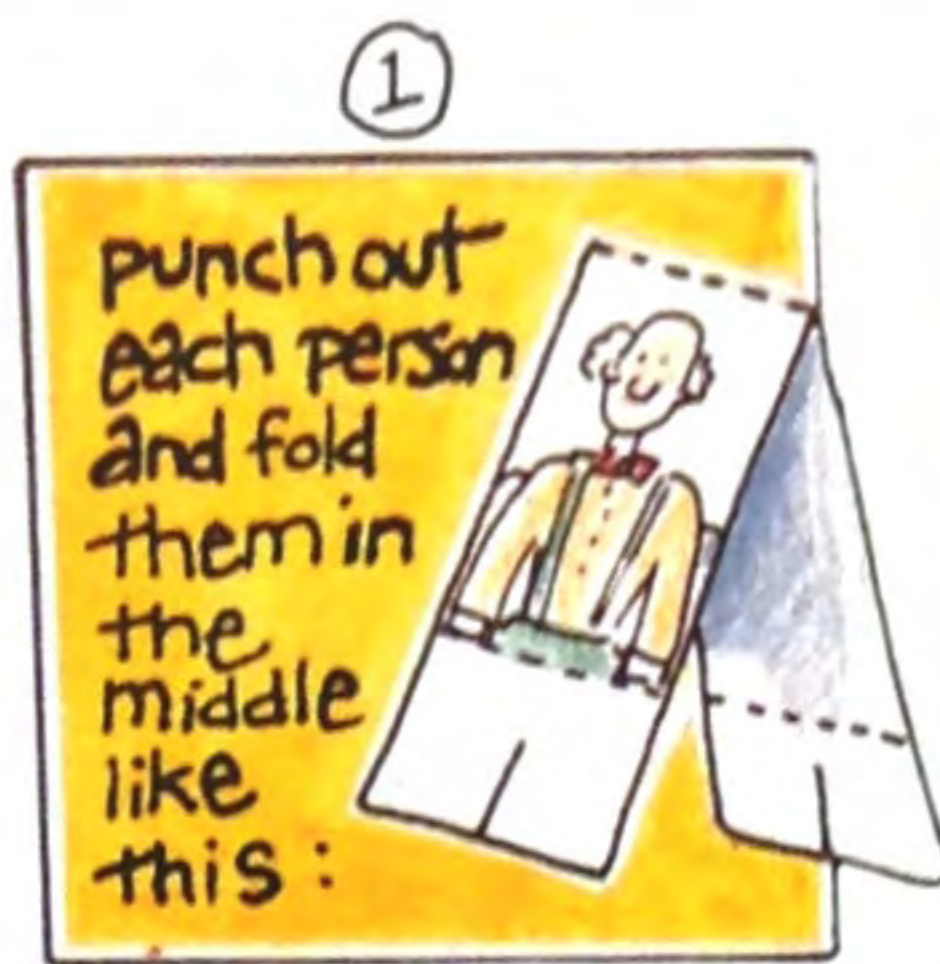

★ If you want to move the people around, just skip step ② and place them on top of the "courtroom board."



↑ People watching in the courtroom ↓

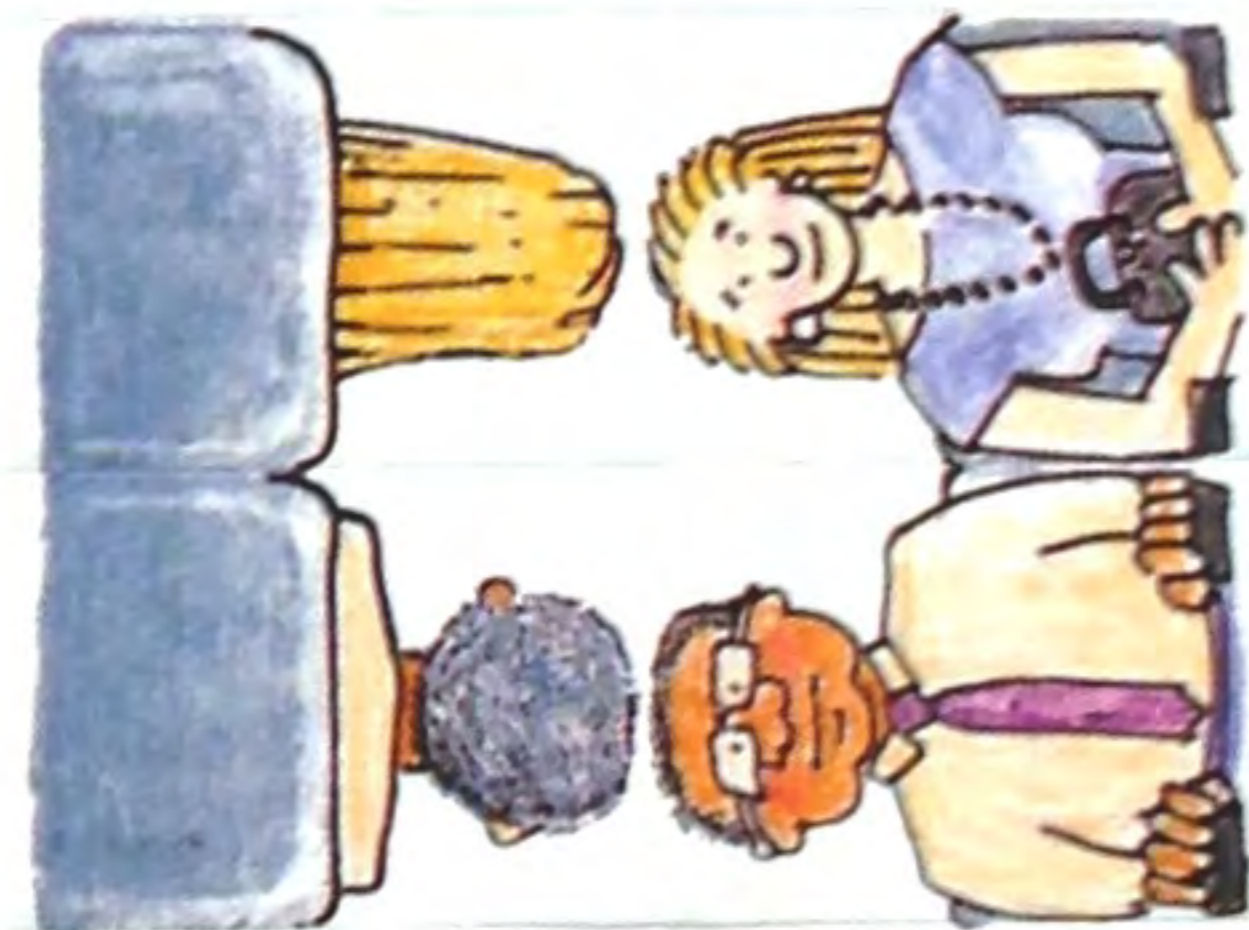

Here's an official "Cory Pal" badge for you to wear!



To put on your badge, just use the button slot or a safety pin!





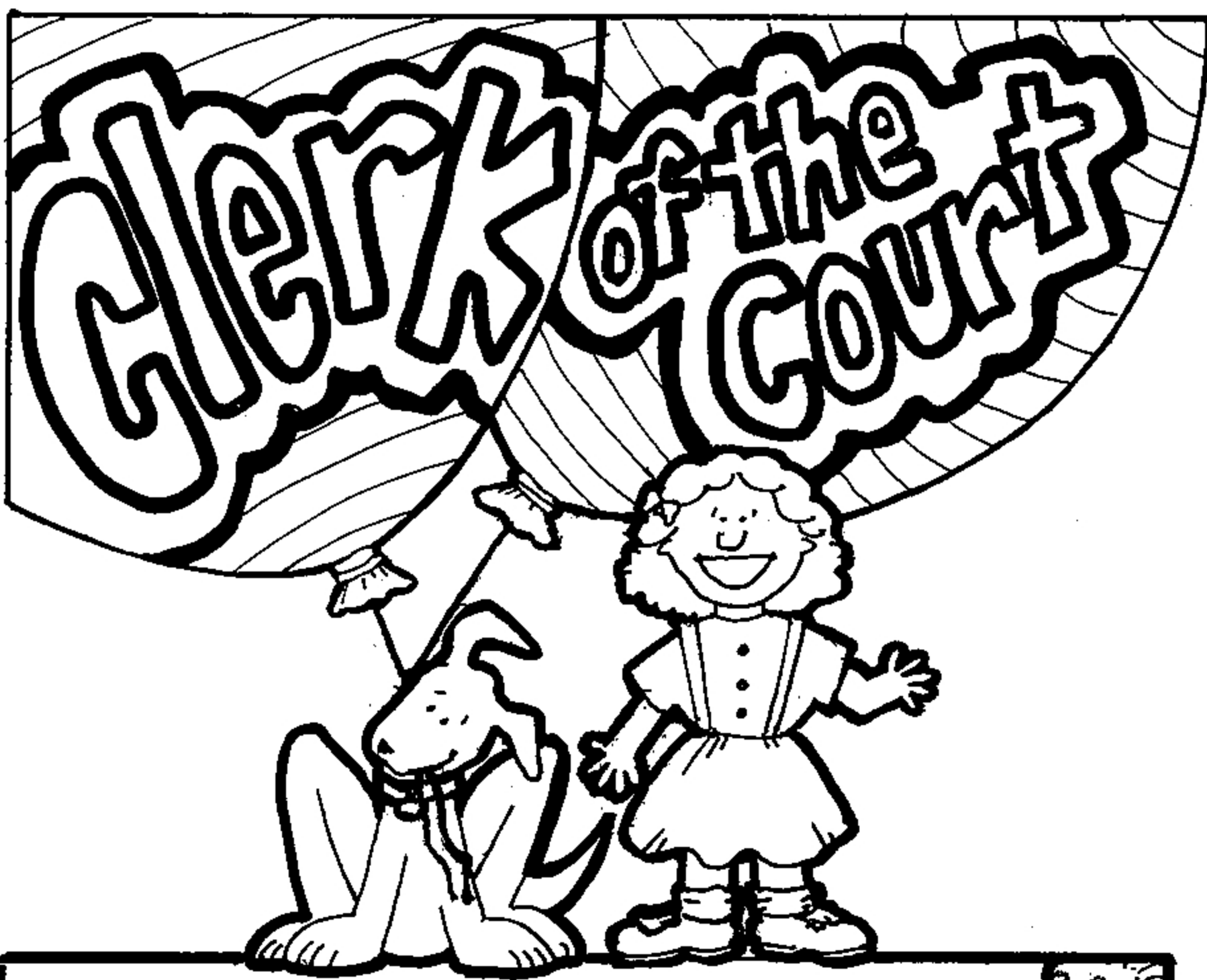

The clerk of the court's job is to help the judge. When the judge comes in, the clerk says, "All rise". That means everybody stand up. The lawyers sometimes bow to the judge. Other people in court don't have to.

The clerk reads out the charge at the beginning of the trial. The clerk may ask us to take an oath. If this happens, the clerk tells us to hold a Bible in our right hand and asks, "Do you swear that the evidence which you are about to give the court in this case shall be the truth, the whole truth, and nothing but the truth so help you God?"

An oath is a promise to God. If you agree to tell the truth, say "I do". Some kids like to do what's called affirming. If you want to affirm instead of using a Bible, the clerk tells you to raise your right hand and asks, "Do you solemnly affirm that the evidence which you are about to give the court in this case shall be the truth, the whole truth, and nothing but the truth?"

If you agree to tell the truth this way, say "I do".

An accused person may be punished because of what witnesses say. That is why it is so important to tell the truth in court. How would you tell the judge in your own words that you will tell the truth?

Cory's having a snack while he waits for his friends in court.

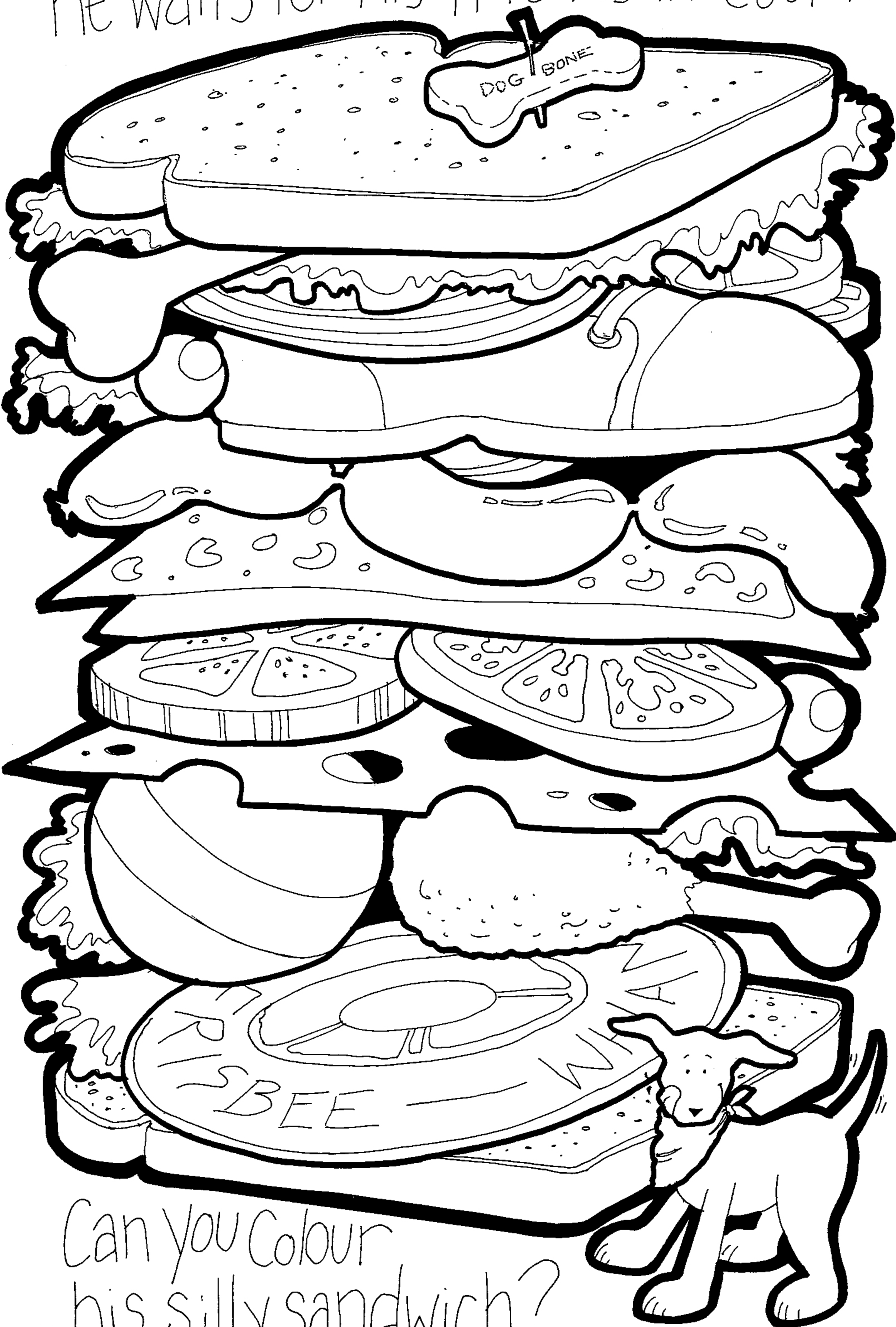

Can you colour  
his silly sandwich?

The

# Court Security Officer

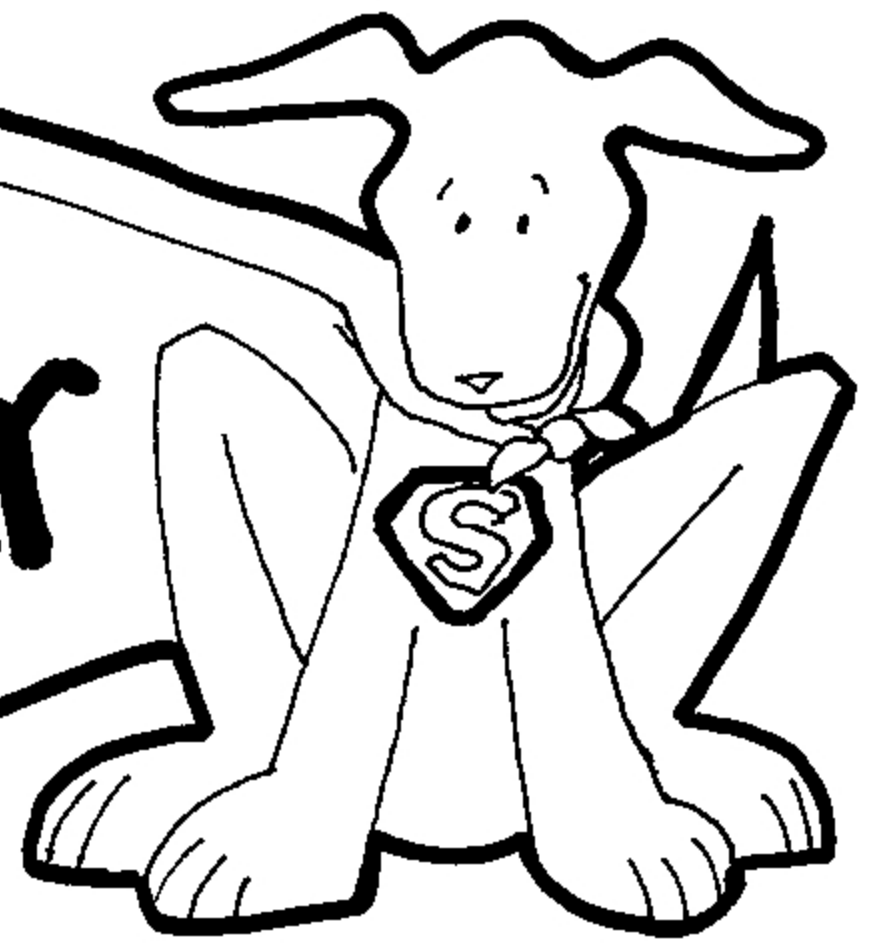

The job of the court security officer is to keep everyone safe in court. Some courtrooms have an officer to make sure that no one hurts or frightens anyone. The officer wears a uniform.

Often, the police officer who spoke with you may be in court. That officer might also be a witness.

If we have any worries or questions about court we can ask the police officer or Crown.

Can you colour the court security officer?

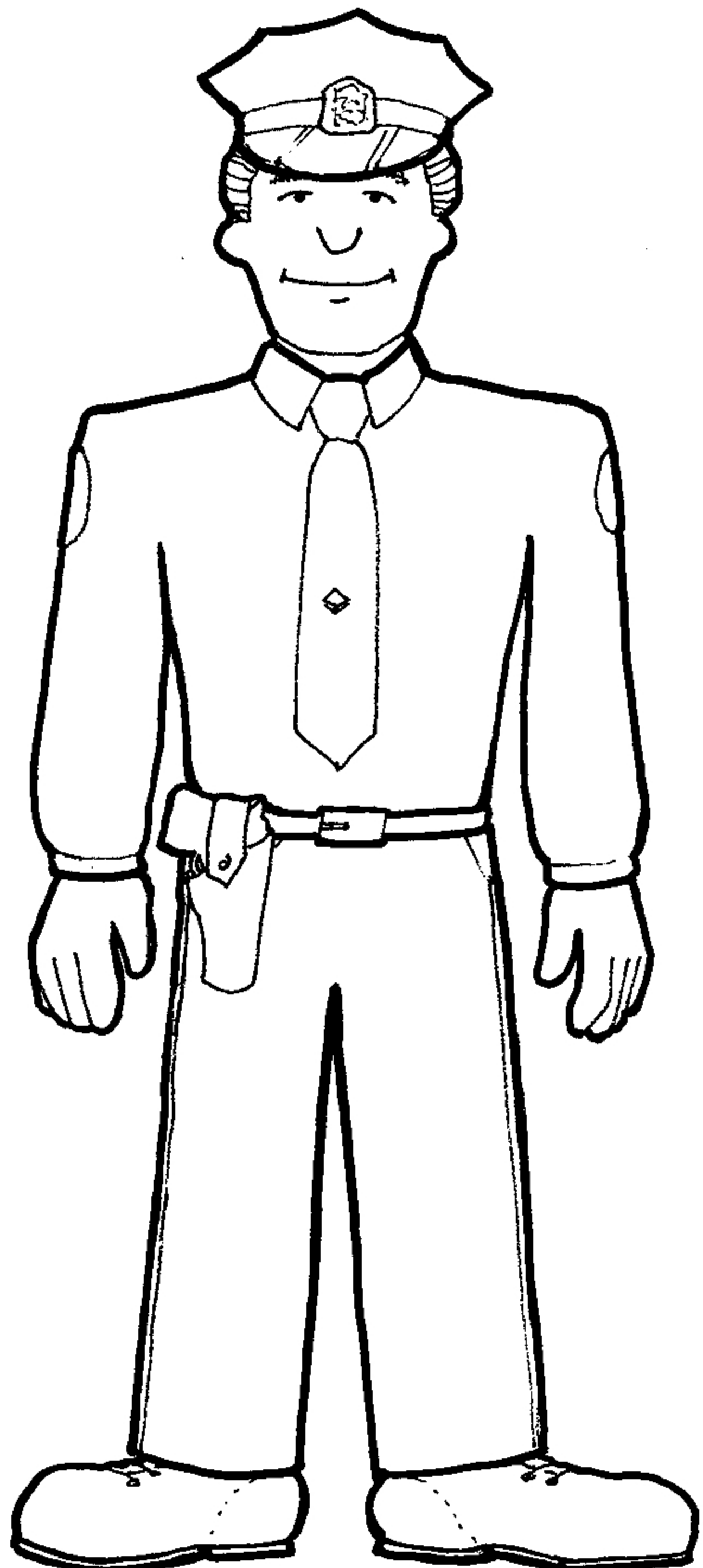

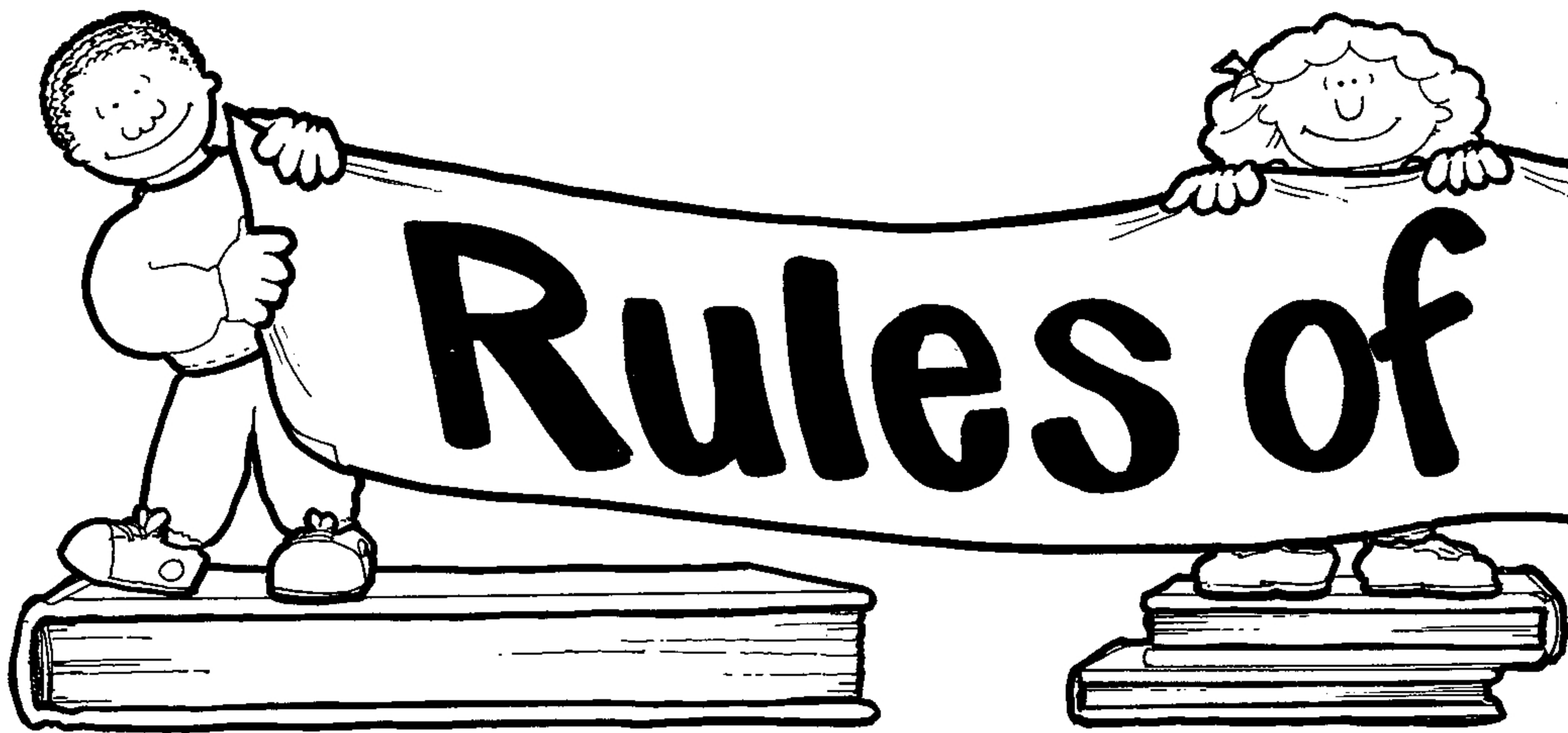

In Canada everybody tries to be very careful and fair when deciding whether people have broken the law or not. That's because if people are found guilty of breaking the law, they can lose some of their freedom.

It is not enough that the judge thinks the accused probably broke the law. The law says that a judge cannot find a person guilty unless the judge feels certain that the person broke the law.

The law says that it is better to let a guilty person go free than to make a mistake and punish someone who didn't break the law.

## Rules for Witnesses

- Tell the truth.
- If you can't remember something or don't understand what someone says, say so.
- If you don't know the answer to a question, say you don't know - don't guess.
- If you don't agree with what someone asks you, tell them that you don't agree.
- If you are sure about the answer to a question, you can say so. If you are not sure, you can tell the judge what parts of your evidence you are less sure of.
- Talk to the judge if something is bothering you or if you have a question while you are being a witness.

# the Court

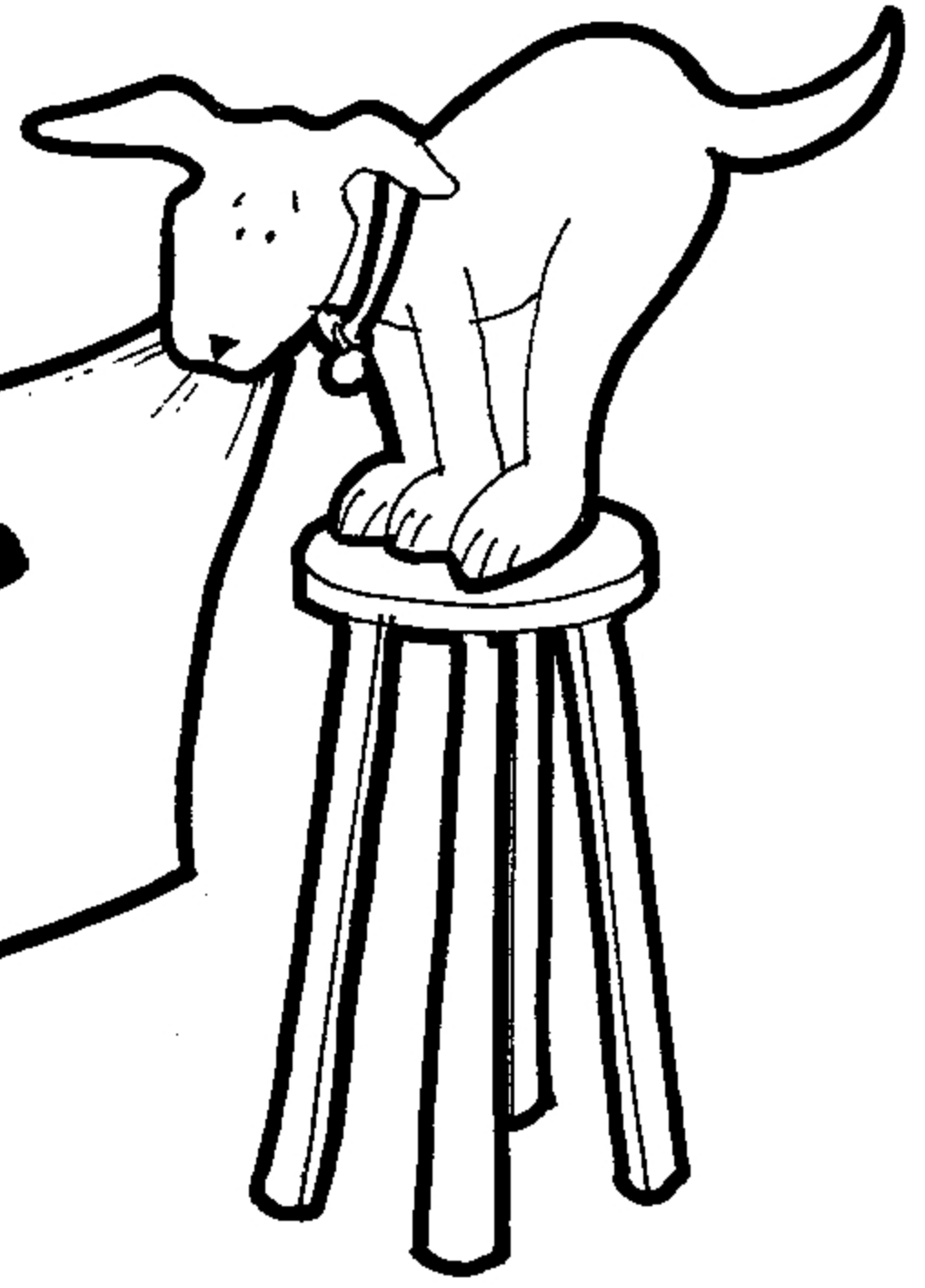

There are a lot of things wrong in this courtroom. How many can you find?

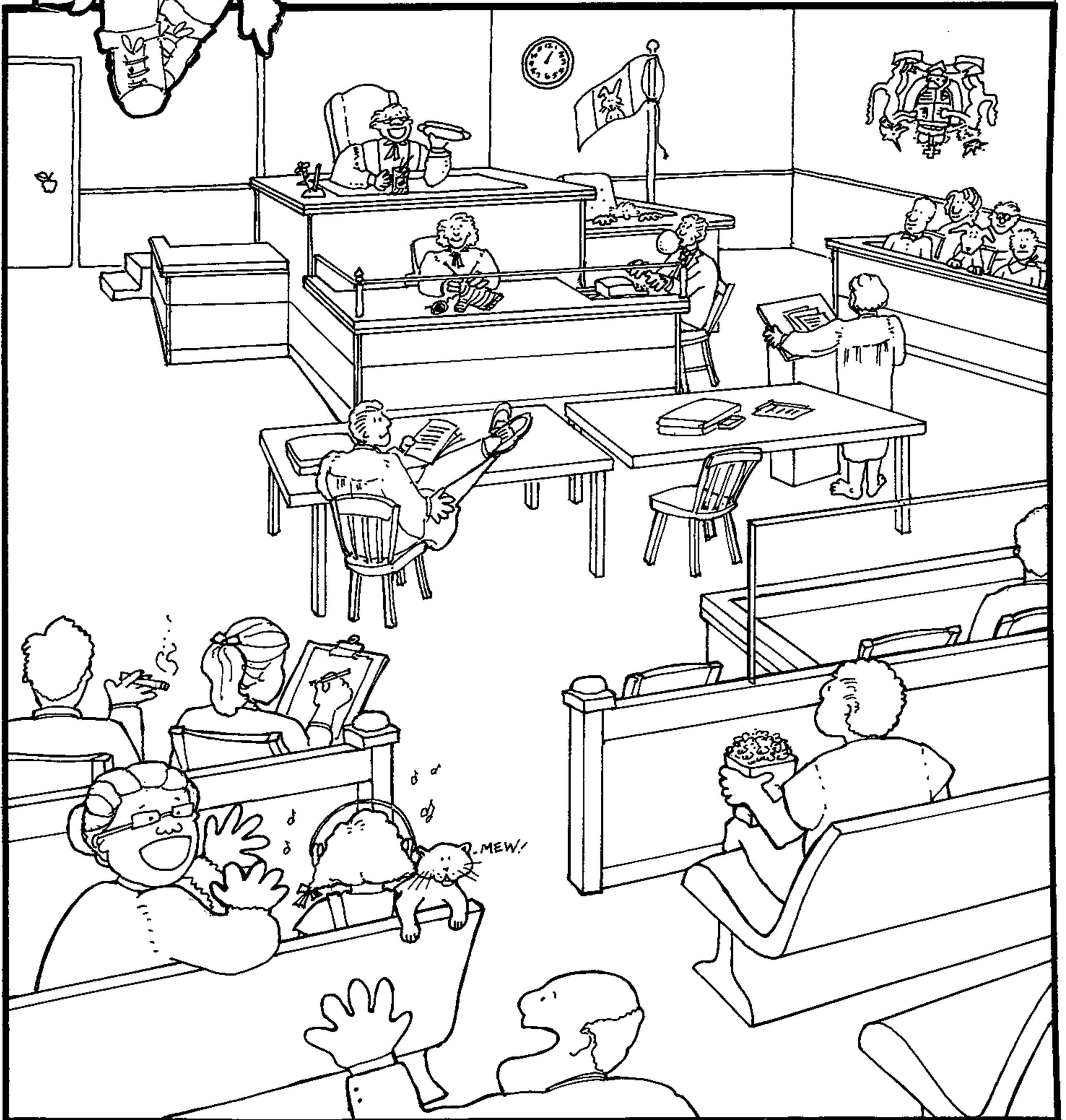

(You can find the answers on page 31.)

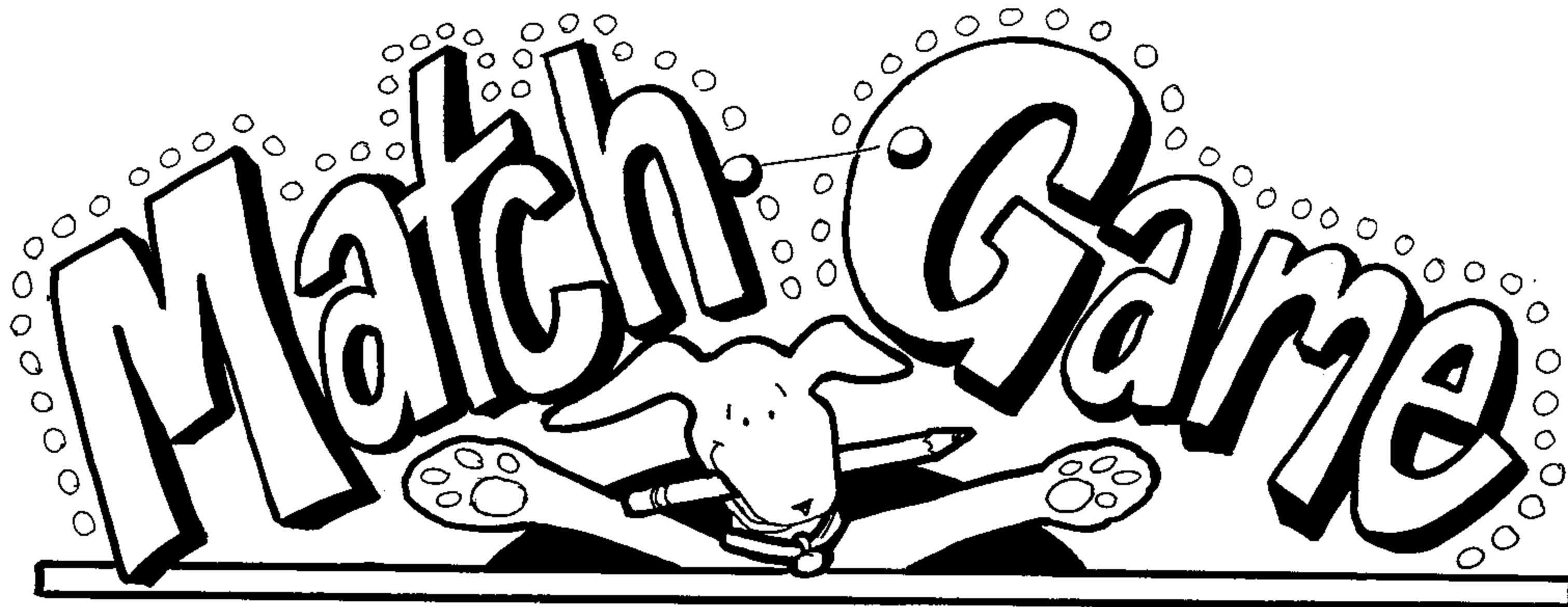

Match the people in column A to their job in column B. The first one is done for you. See the answers on page 31.

A

Judge ●

Crown attorney ●

Defense lawyer ●

Clerk of the court ●

Court reporter ●

Court security officer ●

Jury ●

Witness ●

24 Accused ●

B

● A person who tells the judge about something that happened.

● The person on trial who is charged with breaking the law.

● The person who makes sure everyone is safe in court.

● The person who listens to all the witnesses and decides what happens in the trial.

● The person who helps you to be a witness in court.

● The person who helps the accused in court.

● The person who tells everyone when to stand, reads the charge, and helps witnesses affirm or take an oath.

● The person who records everything in court.

● Twelve people who try to decide together if the accused is guilty or not guilty.

Words are hidden in this puzzle across, up and down, and diagonally. These words are sometimes used in court. When you find a word, circle it and cross it off the list. The first one is done for you. The rest of the answers are on page 31. (But don't peek yet!)

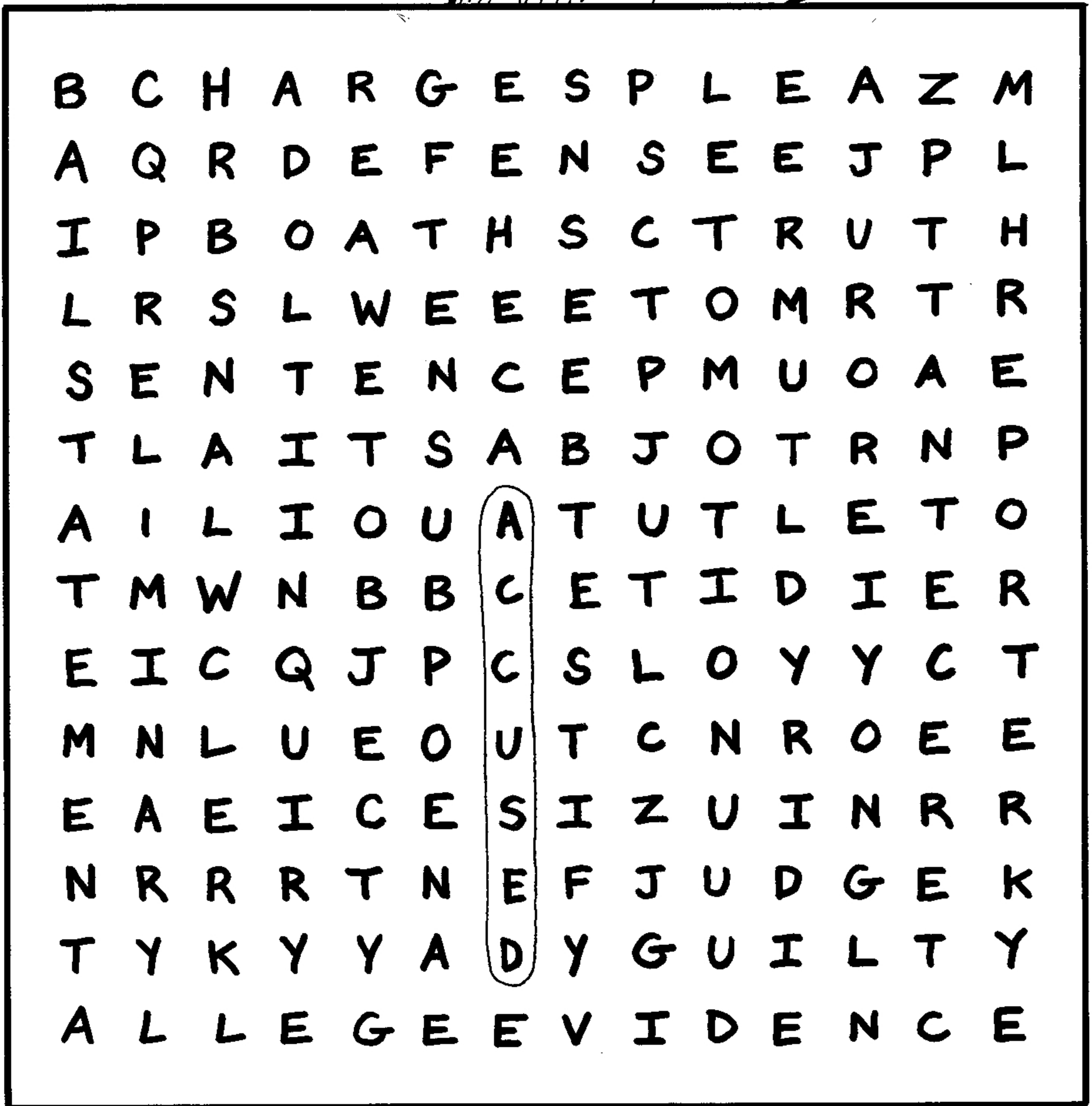

- ACCUSED
- COURT
- INQUIRY
- OATH
- SENTENCE
- ALLEGE
- CROWN ATTORNEY
- JUDGE
- OBJECT
- STATEMENT
- BAIL
- DEFENSE
- JUROR
- PLEA
- SUBPOENA
- CHARGE
- EVIDENCE
- JURY
- POLICE
- TESTIFY
- CLERK
- GUILTY
- MOTION
- PRELIMINARY
- TRUTH
- CODE
- WITNESS



Have you ever had to make an important decision about what to believe?

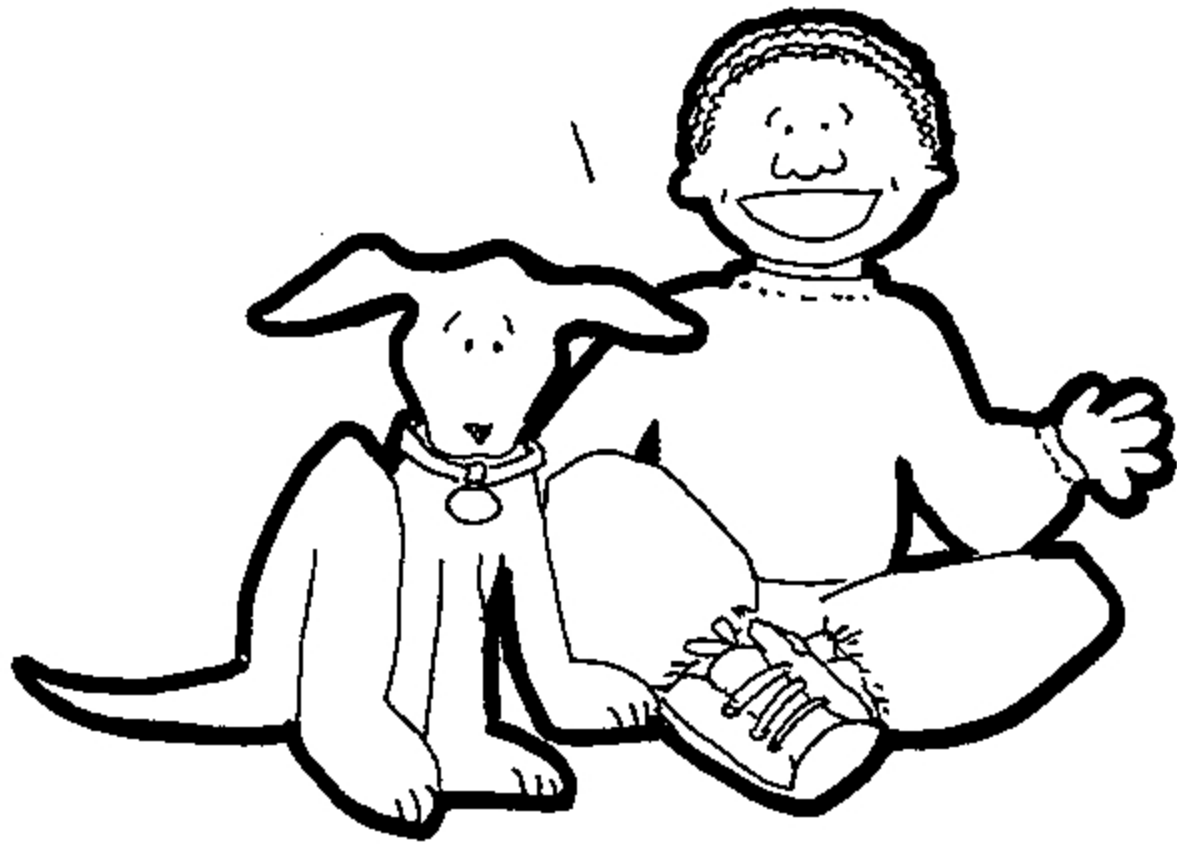

# ~~Guilty~~ not guilty

The judge has to listen to all the witnesses and try to make a decision about what happened. This part of the judge's job is like putting the pieces of a puzzle together.

Sometimes the judge may be confused because some of the pieces are missing and other pieces aren't clear.

Unless the judge feels sure that the accused broke the law, the judge must find the accused not guilty.

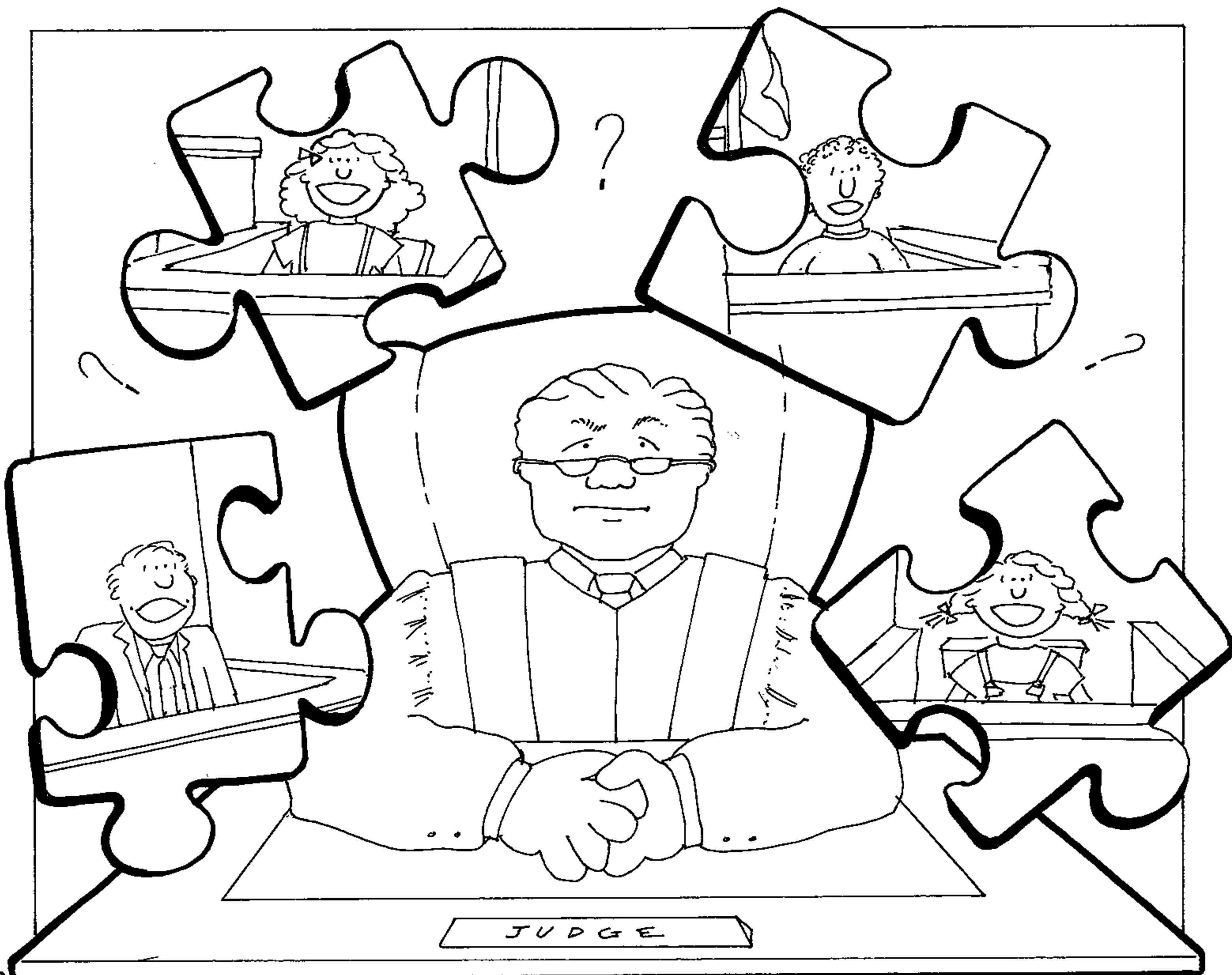

# All about the jury

Most of the time, it's the judge who decides whether or not the accused broke the law. Sometimes, a jury is chosen to do this.

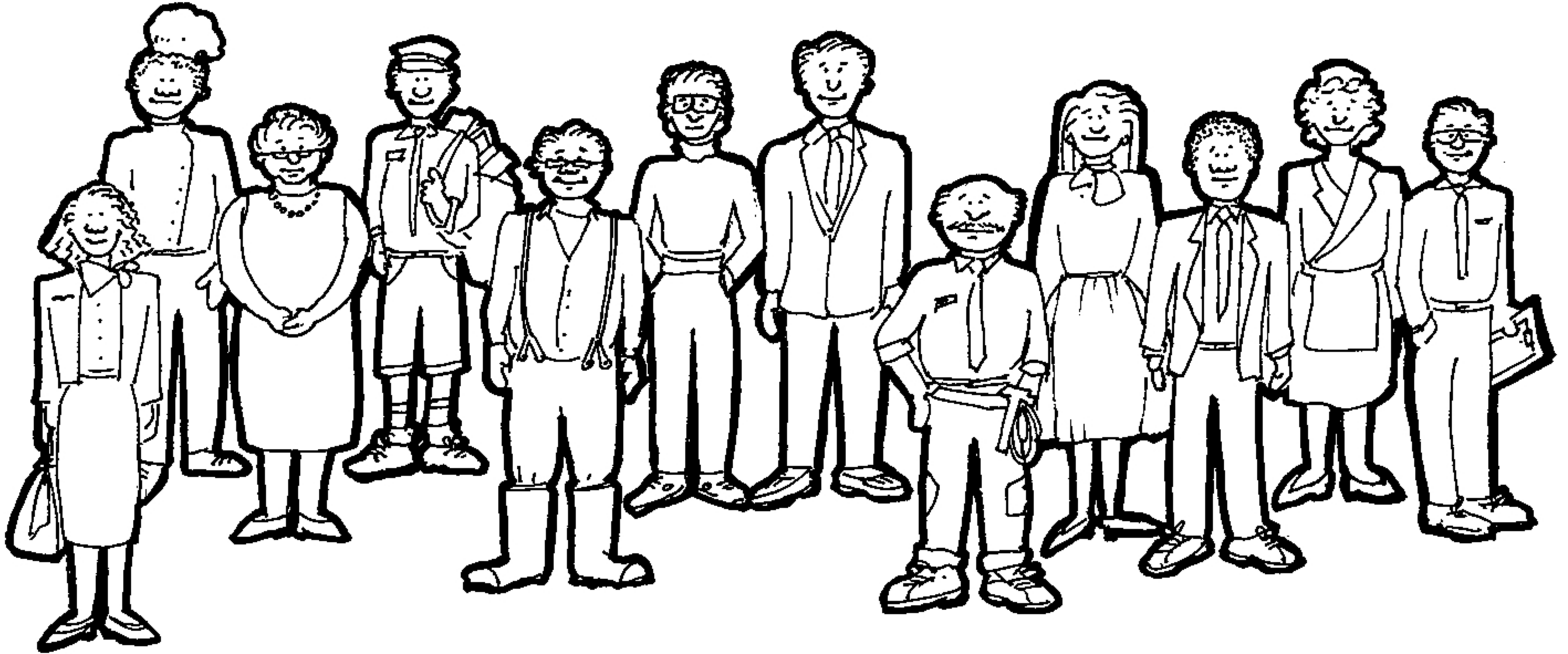

A jury is made up of 12 men and women who are not lawyers. The people on the jury are called jurors, and they are picked by the Crown and the defense lawyer. The jury's job is to listen carefully to all the witnesses and to try to decide together whether the accused is guilty or not guilty of breaking the law.

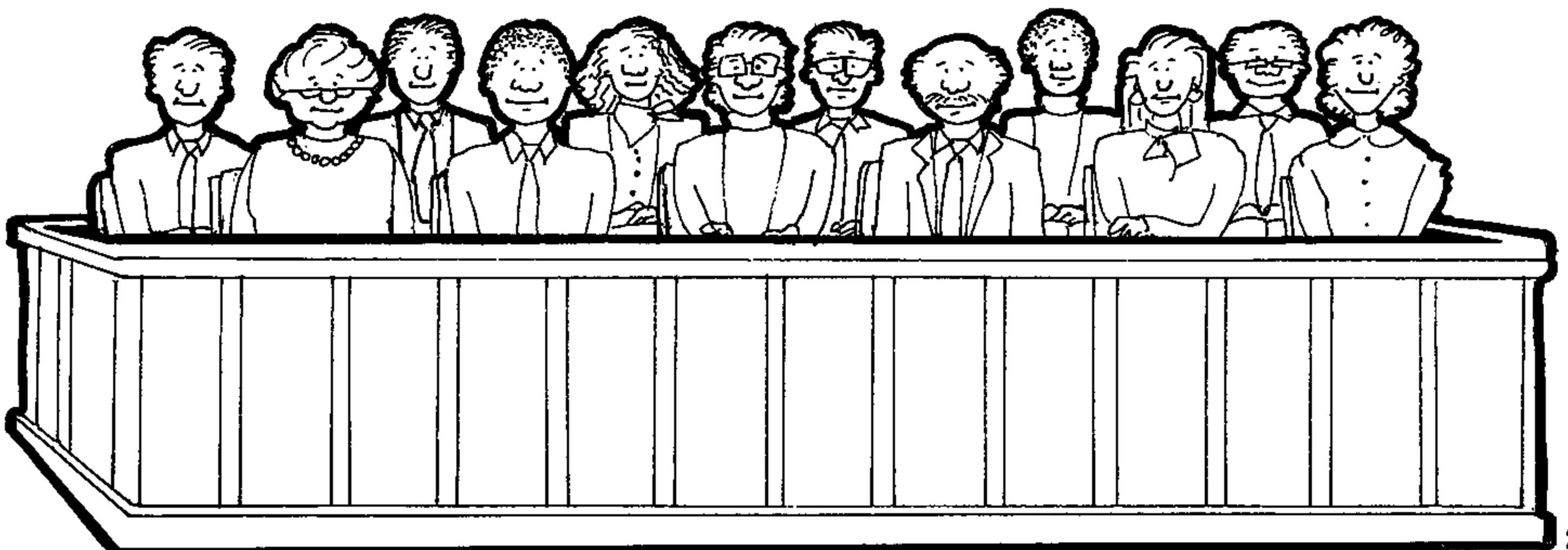

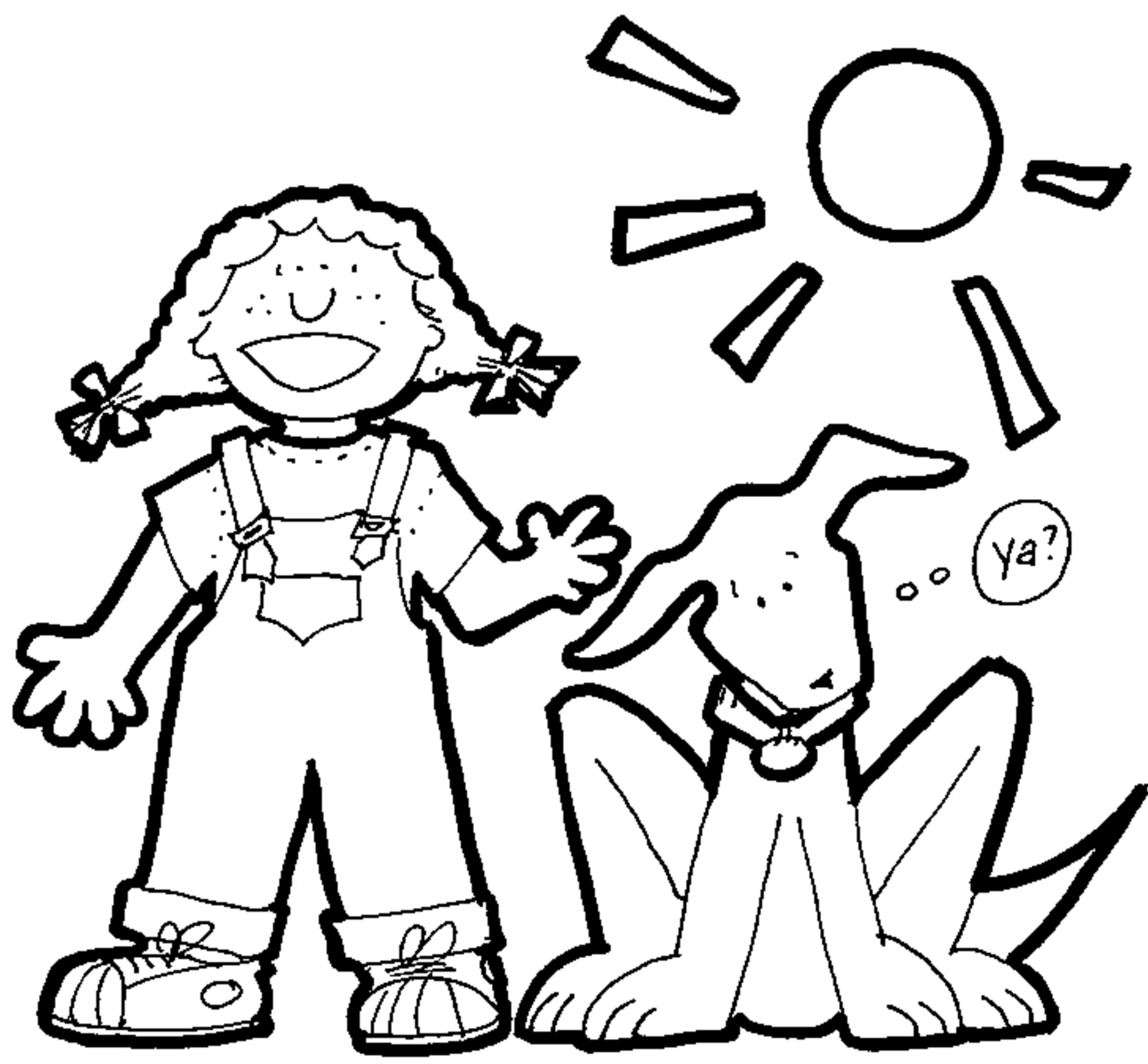

# What happens when my job is over?

Some kids don't want to know what happens in court after they've finished being a witness. Other kids want to come back and find out what the judge or jury decides about the case. We can always talk to the Crown about what we'd like to do.

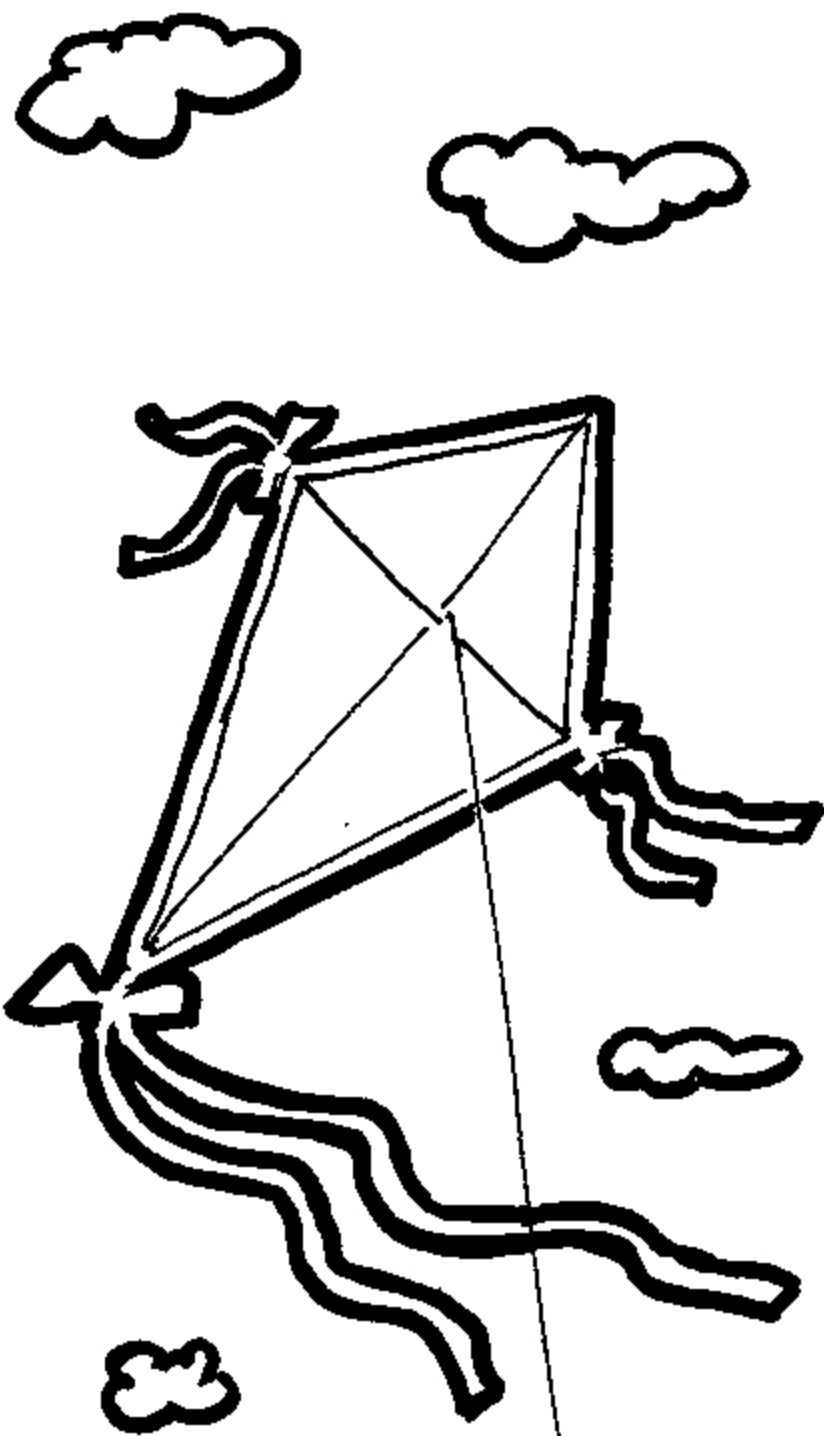
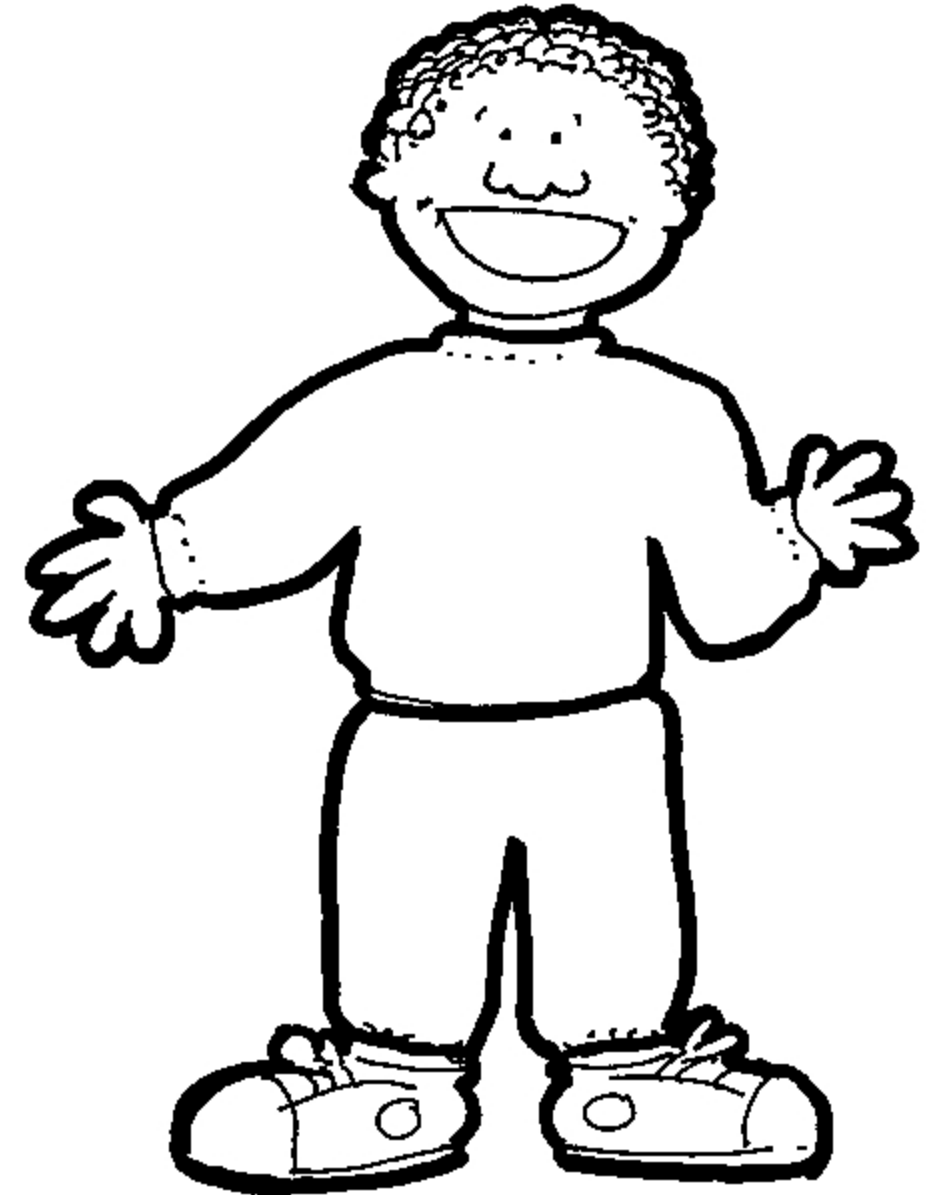

If the judge or jury finds the accused not guilty of breaking the law, the accused is free to go. If the accused is found guilty, one of the things the judge must decide is how to keep the accused from breaking the law again. To do this, sometimes the judge sets rules about what the accused can and can't do, sometimes the judge makes the accused pay money, and sometimes the judge sends the accused to jail.

If we have any questions about what the judge decides in the case, we can ask the Crown.

After it's all over, some kids feel sad or upset. We should all talk to someone we trust about how we feel.

Whatever happens, we'll have done an important job by being witnesses. And we'll have learned a lot about court and what goes on there.



Lots of words in this puzzle are used in court.  
If you want some help,  
the answers are on  
page 31.



# CROSSWORD

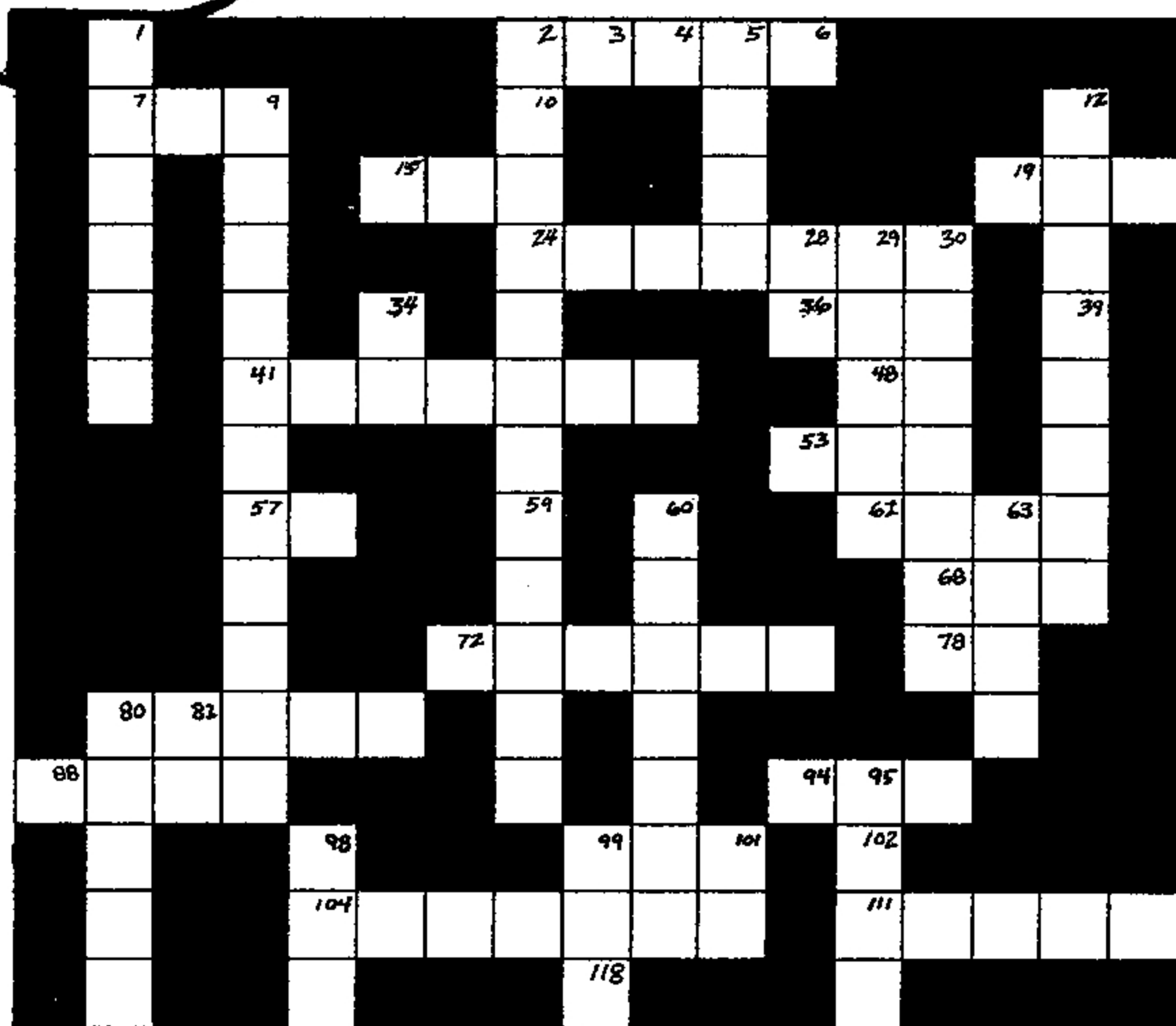

## ACROSS

2. The lawyer who helps you do your job as a witness.
7. The first letter of each word of "Ontario Provincial Police."
15. Another word for "also."
19. When you agree, you say, ----.
24. Someone the police think has broken the law.
36. What word is missing in "shall be ---- truth"?
39.  $4 - 4 = \underline{\quad}$ .
41. To look at closely. (Hint: this word sounds like respect.)

48. The middle two letters in the word "list."
53. A type of airplane.
57. The opposite of out.
59. The first letter of the alphabet.
61. Money that a person who is found guilty has to pay.
68. "A penny --- your thoughts."
72. The person against whom a crime is committed.
78. An old English word that means "you."
80. A person on the jury.

88. Twelve people who decide if the accused is guilty or not guilty.
94. Part of an oath is "so help me ----."
99. If you want to know something, you should ----.
102. The first letter in the word "allege."
104. What the court clerk says when the judge comes into court.
111. It is important that all the witnesses tell the ----.
118. The first letter in the word "day."

## DOWN

1. You can call the judge "Your ----."
2. What the defense lawyer may do to check your evidence.
5. A yellow and black insect that stings (and doesn't make honey).
9. A hearing where the judge decides whether there is enough evidence for a full trial.
12. The person who records what everyone says in court is the court ----.

28. The initials for "Extra Terrestrial."
29. The leader of a native tribe.
30. Answer questions in court.
34. The two middle letters of the word "miss."
60. A person who answers questions in court for the judge to hear.
63. The French word for "Christmas."
72. A sign for victory.

80. The person who listens to the witnesses and decides what happens in the trial.
81. Two letters that sound like "you are."
88. The first letter in the word "jury."
95. A promise to God to tell the truth.
98. A boy's name (rhymes with "ham.")
99. Another word for "help."
101. The cottage is on a la --.

# "What does that mean?"

In court, people use a lot of words that we may never have heard before. Here's a list of some of them:

## Adjourn:

Put off a hearing until another time.

## Allegation:

Something that someone says has happened.

## Charge:

The law that the police believe the accused has broken.

## Complaint:

A statement to the police accusing someone of breaking the law.

## Cross-examine:

Questioning of a witness by the lawyer on the other side.

## Evidence:

Things that witnesses say in court and things (such as photographs, clothes, or drawings) that are brought to court to show what happened.

## Interview:

A meeting with the police or Crown.

## Juror:

A person who is on the jury.

## Objection:

A reason that a lawyer interrupts a witness to talk to the judge.

## Plea:

The answer the accused gives (guilty or not guilty) to the charge that is read out loud at the beginning of the trial.

## Preliminary Inquiry:

A hearing where the judge decides whether there is enough evidence to hold a trial in another court.

## Sentence:

The punishment the judge gives to someone found guilty of breaking the law.

## Statement:

A description that a witness gives to the police and that the police write down.

## Subpoena:

A piece of paper that tells a witness when and where to come to court.

## Testify:

Answer questions in court.

## Testimony:

What a witness says in court.

## Transcript:

A typewritten record that is made by the court reporter of what is said in court.

## Trial:

A hearing that takes place when the accused pleads "not guilty" and witnesses are required to come to court to give evidence.



# Answer Page

## WHERE DOES EVERYBODY SIT?:

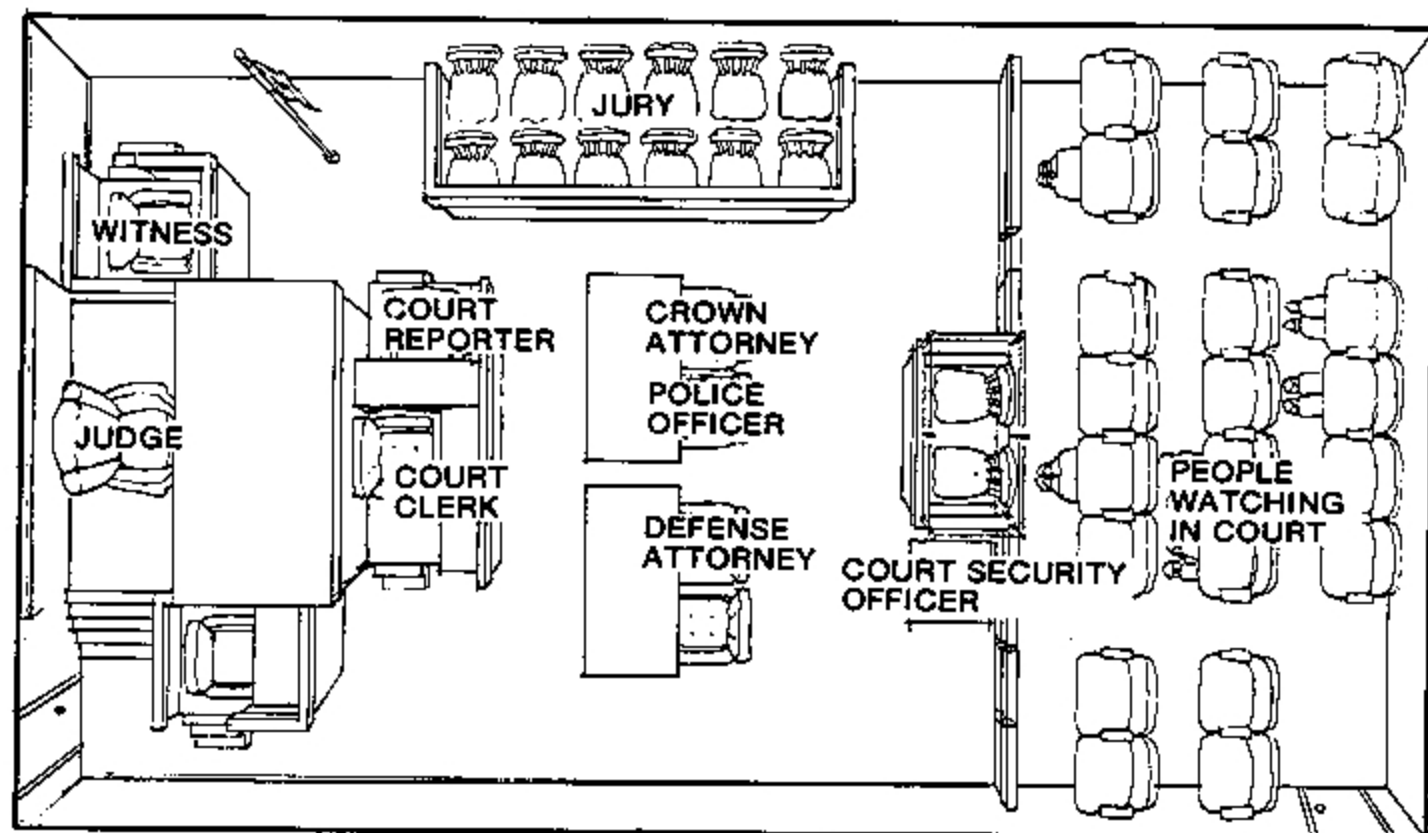

If you have any questions about where the accused is going to sit, ask the Crown.

## CONNECT THE DOTS:

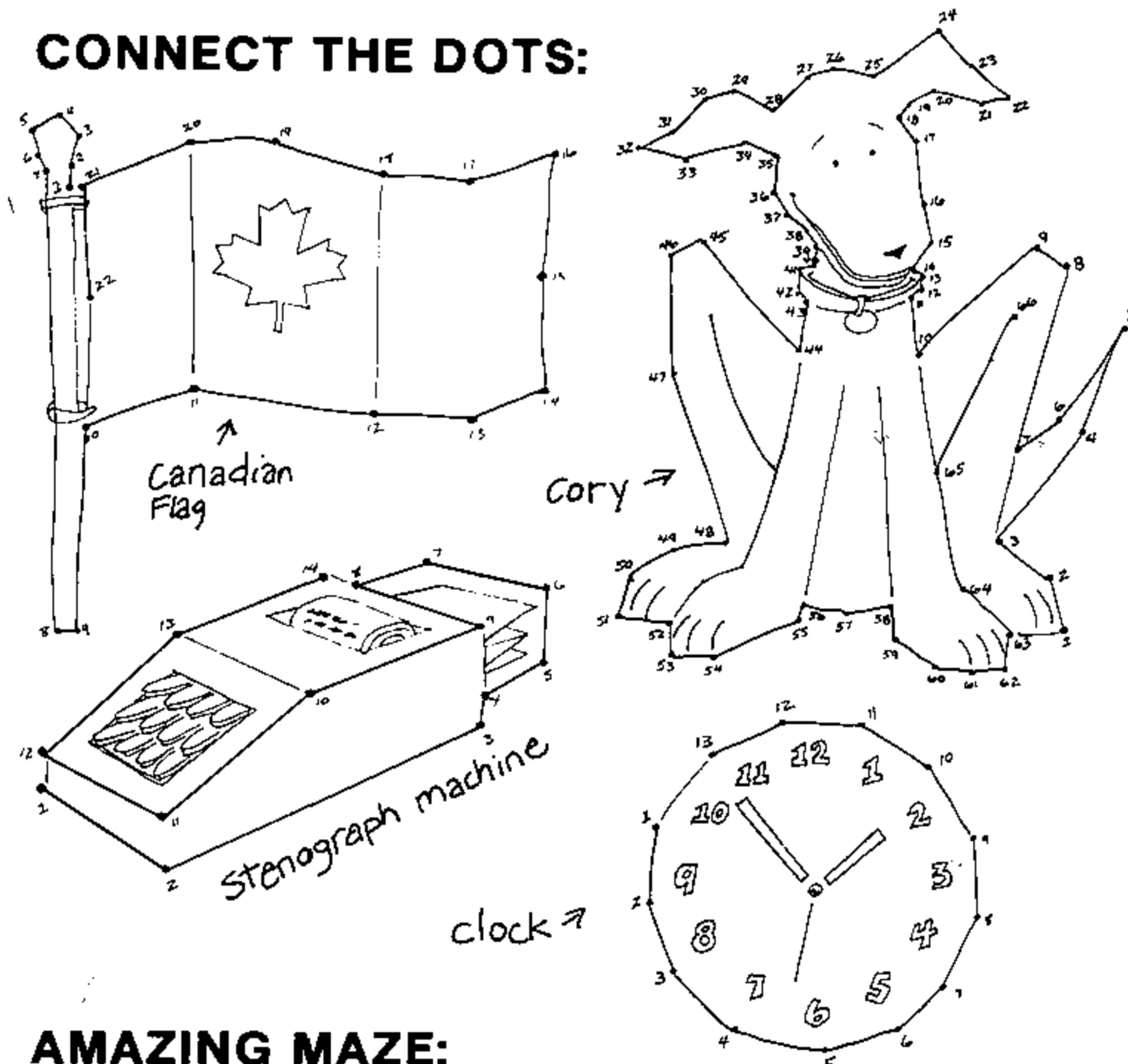

## WHAT IF . . .

1. If you don't understand what people are asking, say "I don't understand". If they repeat it and you still don't know what they mean, ask them to say it in a different way or an easier way.
2. You might be asked about things that you don't remember or about things that didn't happen. If you don't remember, say "I don't remember". Don't guess. If you know something never happened, say so. If you forget the order in which things happened, it's okay. The most important thing is to tell the truth.
3. You might be asked to talk about things that are embarrassing. That's hard to do. Remember that judges and lawyers and everyone in court have heard people talk about embarrassing things a lot of times. You can tell the judge you're embarrassed, but you should tell the judge what happened even if it is embarrassing.
4. Lots of people cry in court. It's okay. If you think you might cry in court, tell the Crown. The Crown can make sure there are tissues. Tell the Crown what you want to happen if you cry: do you want a break or do you want to keep on going?
5. It's always a good idea to go to the washroom just before you go into court to be a witness. If you need to go to the washroom while you're giving evidence, tell the judge you need a break. If you're nervous about doing this, talk to the Crown before court about what you should do. You might agree to raise your hand so that the Crown can tell the judge you need a break.
6. It is easy to get mixed up or to mix up people who are listening to you if you're asked too many questions at a time. You might tell the lawyer who is asking you questions to ask you only one thing at a time so that you can answer properly.

## AMAZING MAZE:

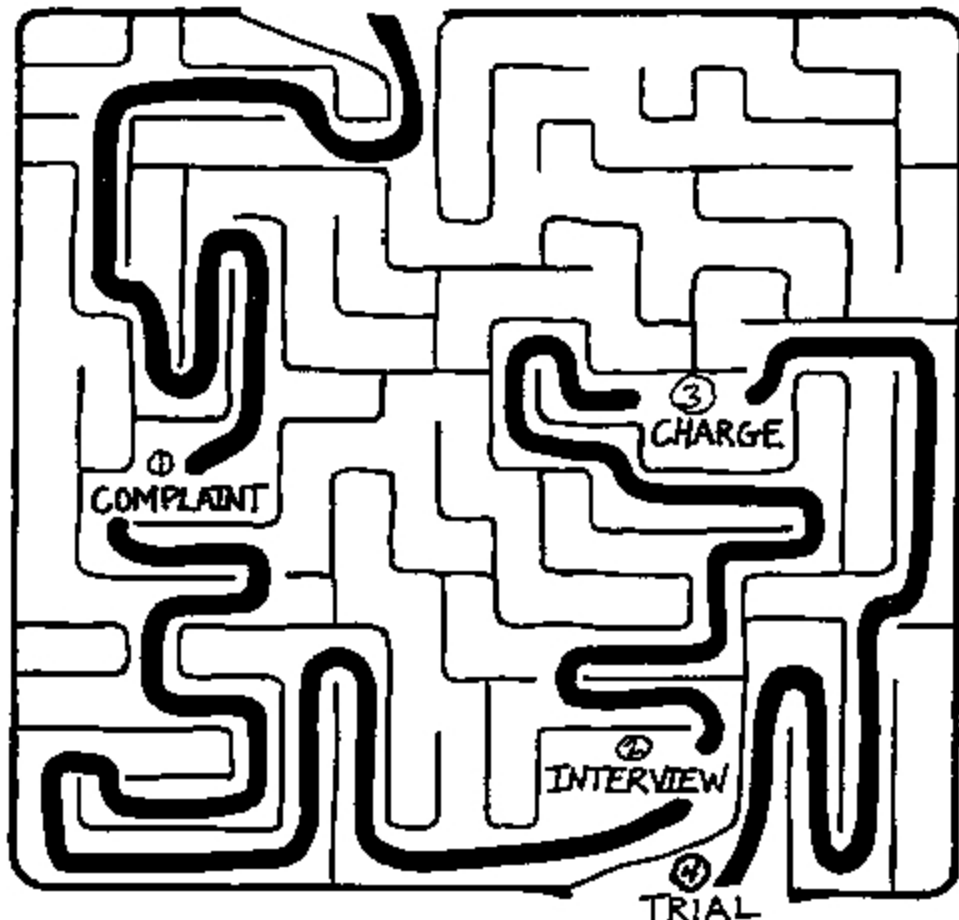

## MATCH GAME:

- JUDGE:** The person who listens to all the witnesses and decides what happens in the trial.
- CROWN ATTORNEY:** The person who helps you to be a witness in court.
- DEFENSE LAWYER:** The person who helps the accused in court.
- CLERK OF THE COURT:** The person who tells everyone when to stand, reads the charge, and helps the witnesses affirm or take an oath.
- COURT REPORTER:** The person who records everything in court.
- COURT SECURITY OFFICER:** The person who makes sure everyone is safe in court.
- JURY:** Twelve people who try to decide together if the accused is guilty or not guilty.
- WITNESS:** A person who tells the judge about something that happened.
- ACCUSED:** The person on trial who is charged with breaking the law.

## FIND THE WORD:

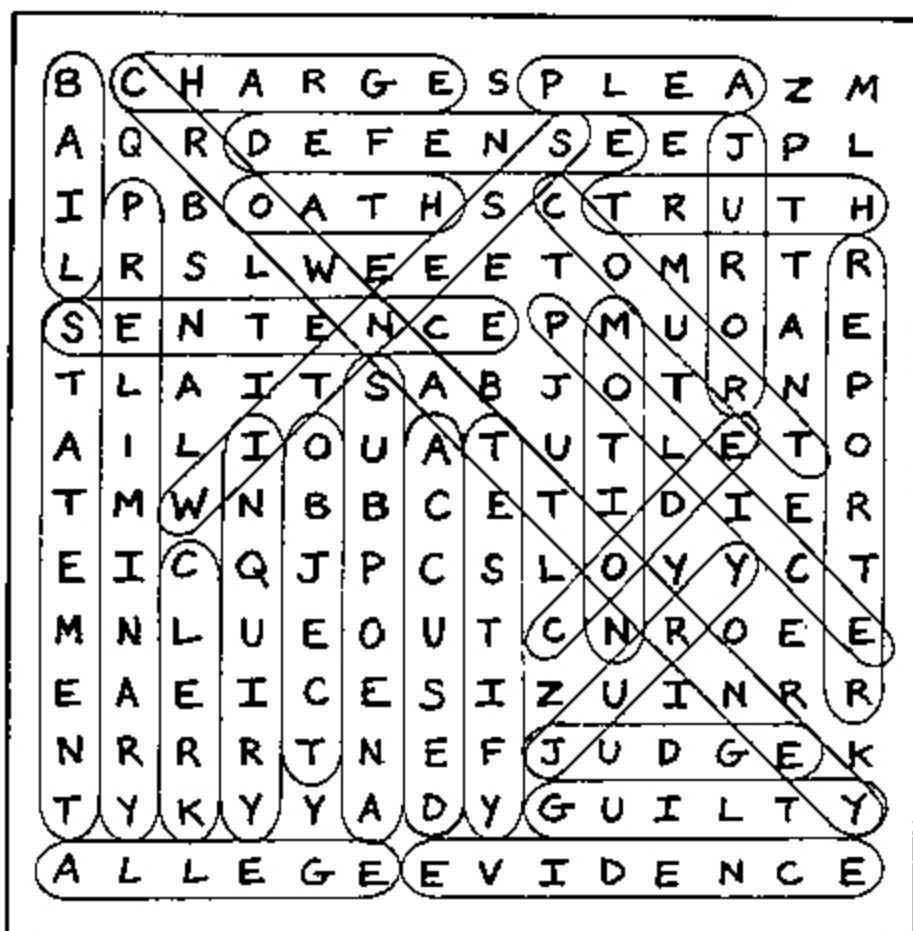

## WHAT'S WRONG IN THIS COURTROOM?:

1. The judge is eating a hot dog and drinking a can of pop. You should not eat in court but it is a good idea to bring a snack with you while you wait.
2. The witness can hardly see over the witness box. If you can't see properly when you are in the witness box, ask the Crown for a different chair or a booster seat.
3. There is an apple instead of a doorknob on the courtroom door.
4. The clock only has one hand.
5. There is a flower growing out of the judge's pen holder.
6. There is a rabbit on the Canadian flag instead of a maple leaf.
7. The Coat of Arms is upside down.
8. The clerk of the court is knitting a sweater. She should be listening to what is happening in court and ready to help the judge.
9. The court reporter is blowing bubble gum. Don't chew gum in court!
10. Cory is sitting in the jury box! Cory didn't notice that there is a kitten in the courtroom. Pets are not allowed in court, but if you would like to bring a special toy to hold while you are waiting, that's fine. If there is someone you want to come into the courtroom with you, ask the Crown.
11. The Crown attorney has bare feet. That may be okay to go to the beach, but in court try to be neat and comfortable, and do wear shoes!
12. The defense attorney has his feet up on the desk. Everyone should try to sit up straight in court.
13. There are only 2 legs on the Crown attorney's table.
14. People sitting in the seats are talking. They should try not to talk while the judge is in court. If they have to say something, they should whisper or leave quietly and talk outside.
15. Someone is eating popcorn. This is not a movie; going to court is serious. No one should eat while in the courtroom, even if that person is just watching.
16. Someone is listening to a walkman. You shouldn't be listening to a radio in court. You can bring a walkman with you, if you have one, to listen to while you wait for court, but when you are in court, you have to listen carefully to the questions you are asked.
17. Someone is smoking. Smoking isn't allowed in the courtroom.

## COURTROOM CROSSWORD:

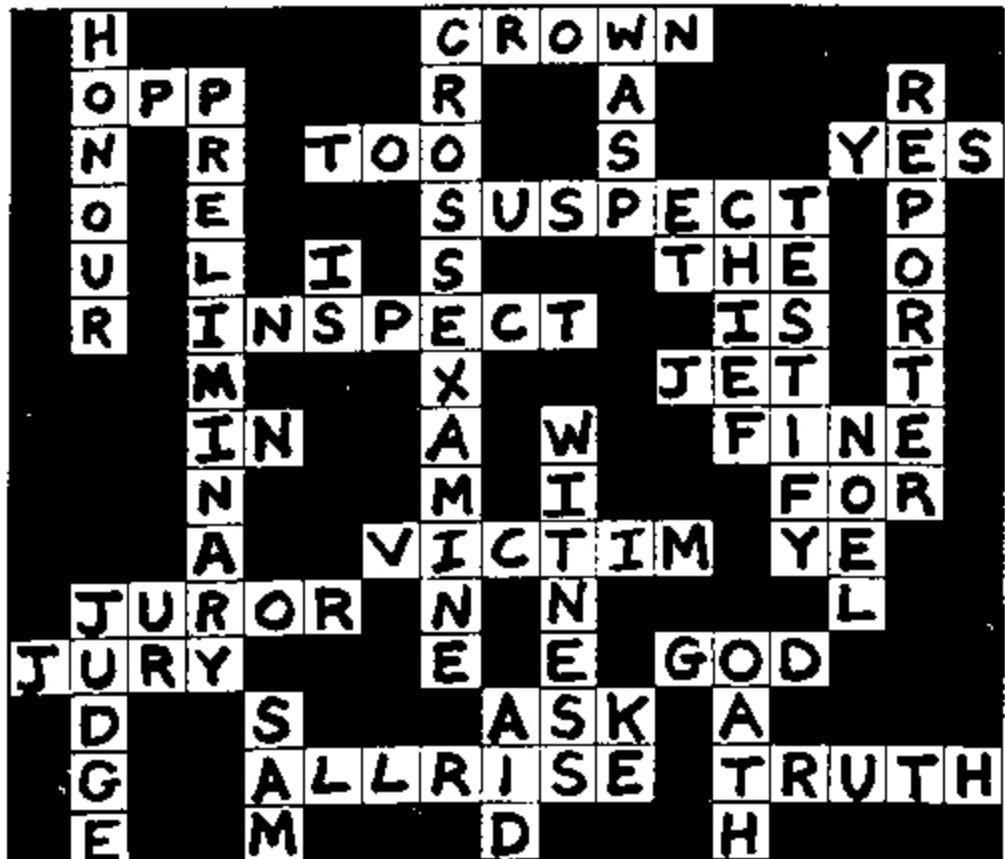

You may want to remember  
Some names, dates and  
places. Here is a place to  
write some of them down.

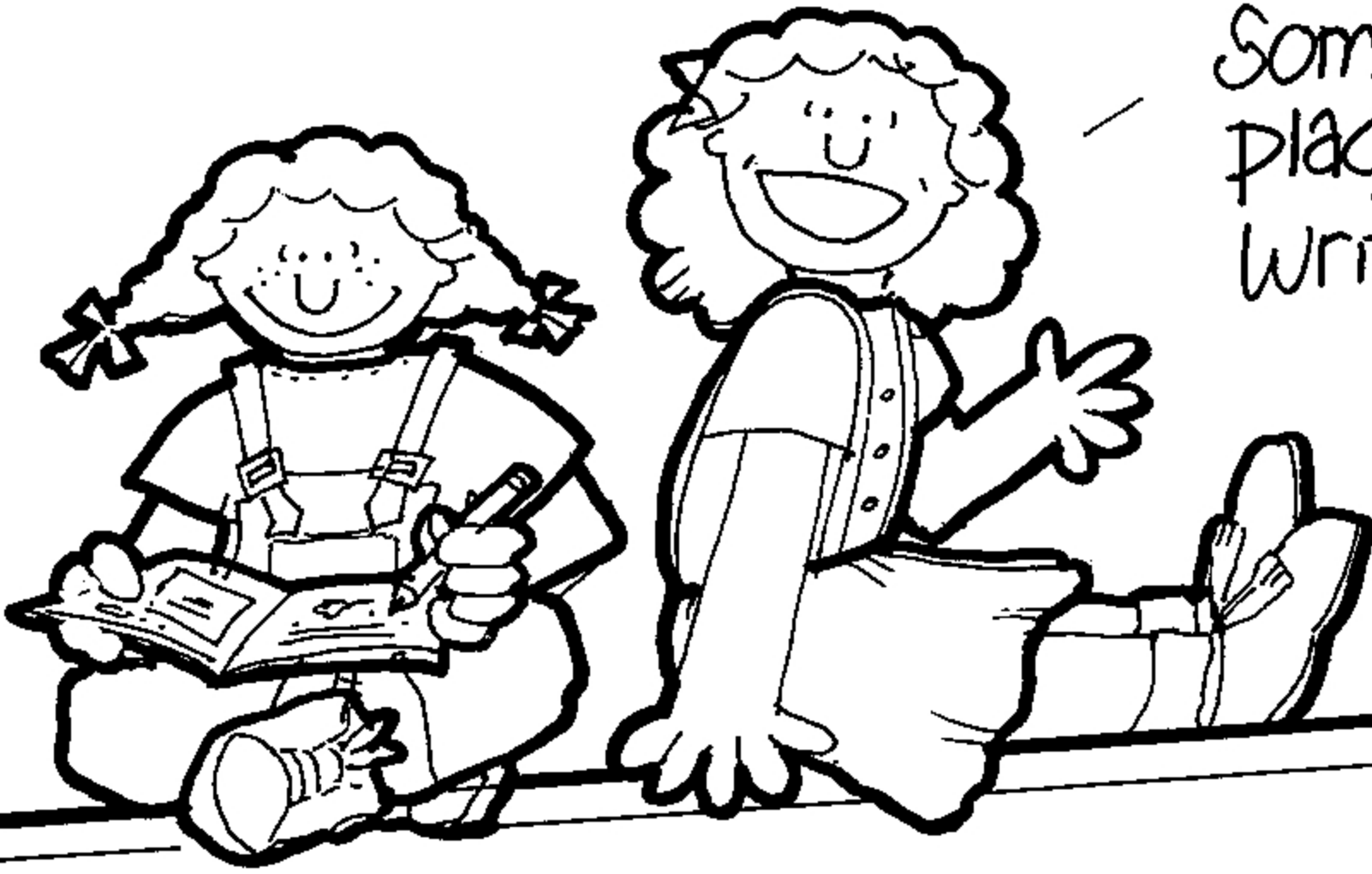

My name is \_\_\_\_\_

The Crown attorney is \_\_\_\_\_  
telephone number \_\_\_\_\_

The police officer is \_\_\_\_\_  
telephone number \_\_\_\_\_

My court date is \_\_\_\_\_ Courtroom number \_\_\_\_\_

I met the Crown attorney on \_\_\_\_\_

My birthday is \_\_\_\_\_ I am in grade \_\_\_\_\_

The name of my school is \_\_\_\_\_

My teacher's name is \_\_\_\_\_

My favourite subject is \_\_\_\_\_

My hobbies are \_\_\_\_\_

the people in my family are \_\_\_\_\_

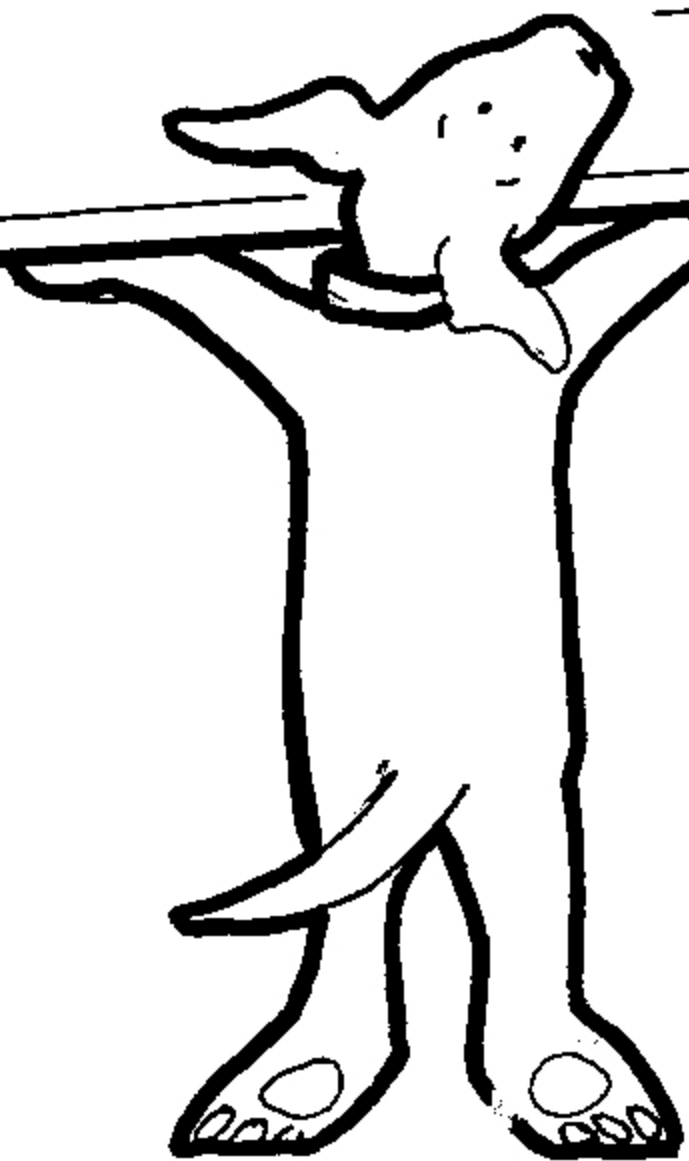

The Crown attorney  
would like to know a  
little bit about you.  
Can you show this  
page to the Crown?

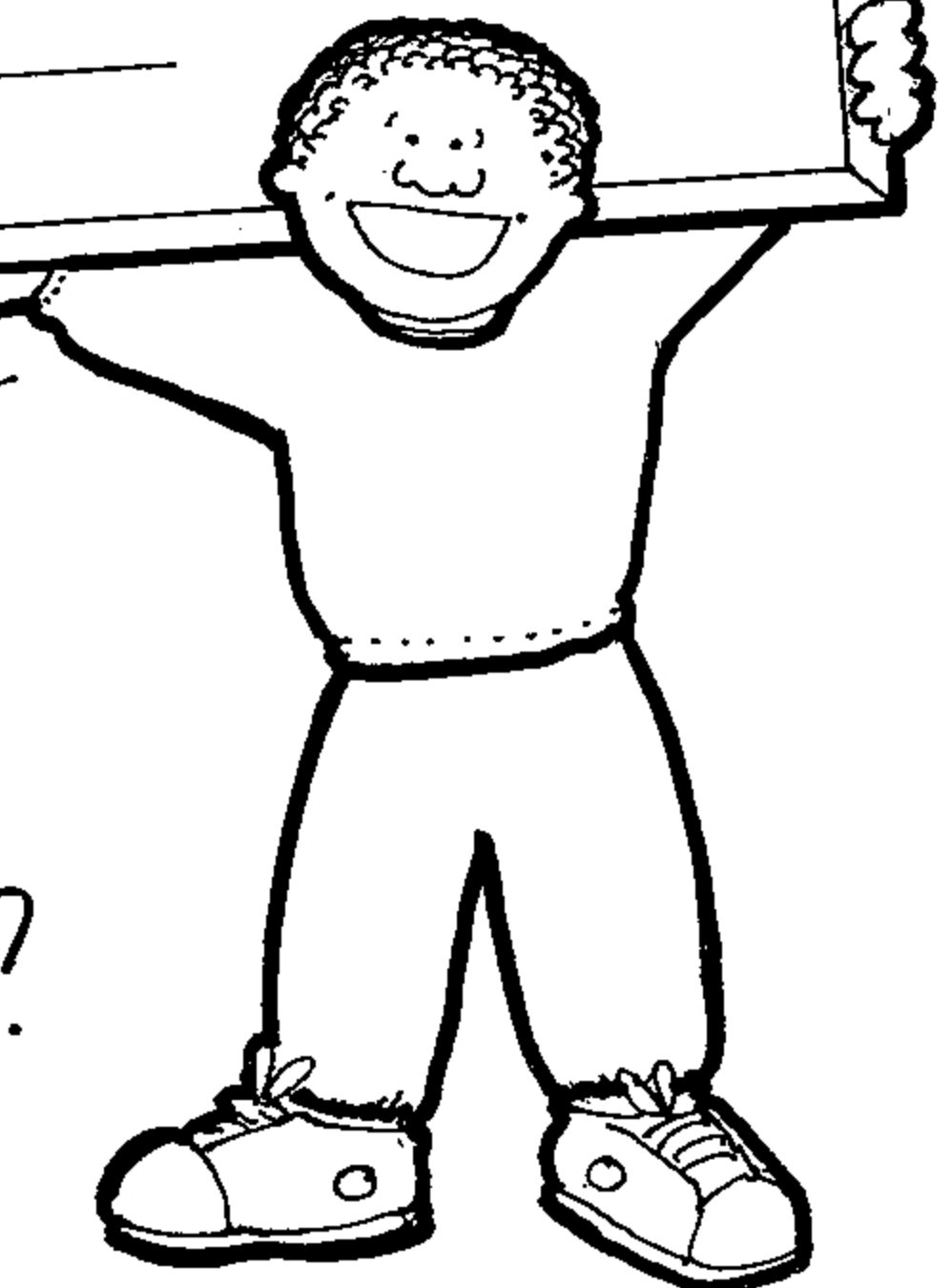

**This booklet was created by the Victim/Witness Assistance Program of the Ministry of the Attorney General of Ontario for children who must testify in court. It is intended to familiarize children in an educational and appealing way with the concepts, people, vocabulary, and events that are a part of the court process.**

**We expect that children will vary in their use of this booklet, depending on their age and interest. Some children may simply want to colour in it while they wait to meet the Crown attorney, or to testify. Others may be interested in the activities and more complex concepts. Some children might use it as a reference to help them understand the criminal court process. It is not meant to replace legal advice nor is it a substitute for careful preparation of children who must testify.**

**We hope that this booklet will encourage dialogue between child witnesses and Crown attorneys as well as other supportive adults. We also hope that it will help adults to understand the fear and confusion that children feel when they are faced with the job of testifying and enable both children and adults to ask questions and seek answers.**

**The Victim/Witness Assistance Program operates in some criminal courts throughout Ontario and provides support and information for victims and witnesses of all ages. Local coordinators introduce witnesses to the courtroom, explain legal terminology and the judicial process, serve as a liaison between the witness and the Crown attorney, and offer referrals to psychological, legal, and medical resources in the community. Staff also serve on local committees which coordinate services to victims of crime and provide public and professional education pertaining to victims and the judicial process.**

**The Ministry of the Attorney General is committed to helping victims of crime. The Victim/Witness Assistance Program is an example of this commitment in action.**

## **ACKNOWLEDGEMENTS**

**Susan Lee, Christine McGoey, and Joan Hurley of the Victim/Witness Assistance Program were the authors of this book. Doug Spencer of the Communications Branch of the Ministry of the Attorney General acted as coordinator. The following individuals have enthusiastically contributed their expert advice and suggestions: Myra Lefkowitz, Metropolitan Toronto Special Committee on Child Abuse; Mary Wells, Institute for the Prevention of Child Abuse; Peter Barnes, Crown Attorney; Shelley Hallett, Assistant Crown Attorney; and Wendy Harvey, Crown Counsel, British Columbia.**

